

Original Element Data Sheet

Element Type

Description EPF4-1-05QI-B

Parker Part No. 944443Q

Dimensional References

A (mm) 95,5

B (mm) 61,7

C (mm) 64,2

D (mm) 103

E (mm) 197,2

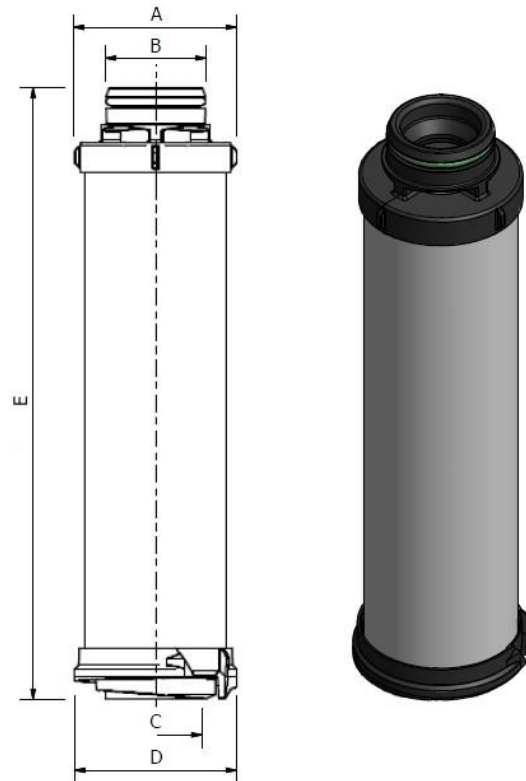

Construction Materials

Seal(s) NBR: Perbunan/Nitrile

Top Endcap Glass reinforced nylon

Bottom Endcap Glass reinforced nylon

Filter Media Multilayer fibreglass with coated mesh on both sides

Performance Criteria

Differential Pressure acc. to ISO3968

Clean element dP @ 30cSt, 270 L/min \approx 0,98 bar

Efficiency acc. to ISO16889, for

$\beta_{x(c)} \geq 200$; x = 6 / $\beta_{x(c)} \geq 1000$; x = 7

Minimum Collapse Pressure acc. to ISO2941

>25 bar (mounted on core in bowl)

Dirt Holding Capacity acc. to ISO16889

@ 5 bar terminal pressure drop \approx 44,9 grams