

Pressure Relief Valve, Spool-Type, Pilot-Operated

SR4A-B2

7/8-14 UNF • Q_{max} 100 l/min (26 GPM) • p_{max} 350 bar (5100 PSI)

Model S

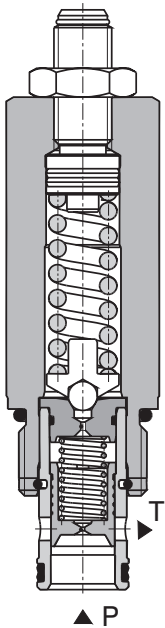

Technical Features

- › Excellent stability throughout flow range with rapid response to dynamic pressure changes
- › Low hysteresis, accurate pressure control and low pressure drop through CFD optimized flow paths
- › Wide pressure range up to 350 bar
- › High flow capacity
- › Hardened precision parts
- › Ideal for use as control valve where accuracy and repeatability is required
- › Adjustable by allen key hand screw
- › In the standard version, the valve is zinc-coated for 240 h protection acc. to ISO 9227

Functional Description

A pilot-operated, spool-type hydraulic relief valve in the form of a screw-in cartridge intended for use as a pressure limiting device. Fast-acting with low hysteresis. Because of the absence of any internal seals, the valve shows excellent reseating and repeatability characteristics. It may be used as a main pressure control element but due to its two stage design it is not recommended for safety applications where operating speed is critical.

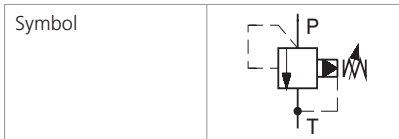

Technical Data

Valve size / Cartridge cavity		7/8-14 UNF-2A / B2
Max. flow	l/min (GPM)	100 (26)
Max. operating pressure	bar (PSI)	350 (5080)
Max. pressure (T port)	bar (PSI)	100 (1450)
Fluid temperature range (NBR)	°C (°F)	-30 ... +100 (-22 ... 212)
Fluid temperature range (FPM)	°C (°F)	-20 ... +120 (-4 ... 248)
Mass	kg (lbs)	0.24 (0.53)

		Datasheet	Type
General information		GP_0060	Products and operating conditions
Valve bodies	In-line mounted	SB_0018	SB-B2*
	Sandwich mounted	SB-04(06)_0028	SB-*B2*
Cavity details / Form tools		SMT_0019	SMT-B2*
Spare parts		SP_8010	

Characteristics measured at $v = 32 \text{ mm}^2/\text{s}$ (156 SUS)

Relief pressure related to flow rate

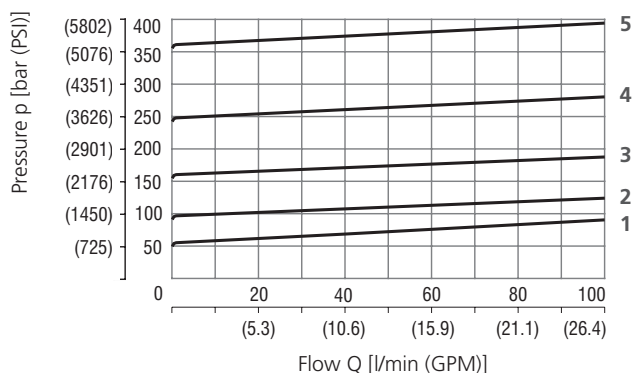

	Pressure range
5	35
4	25
3	16
2	10
1	6

Minimum set and circulation pressure

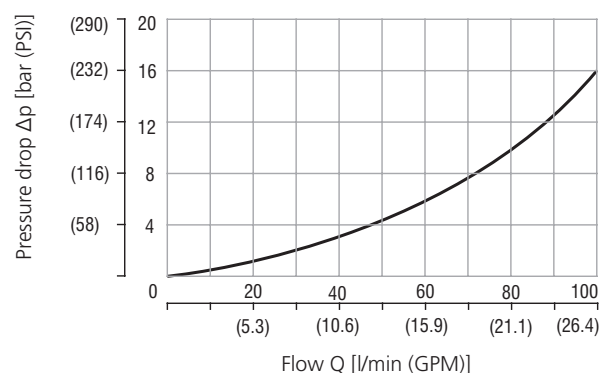

Dimensions in millimeters (inches)

Model S

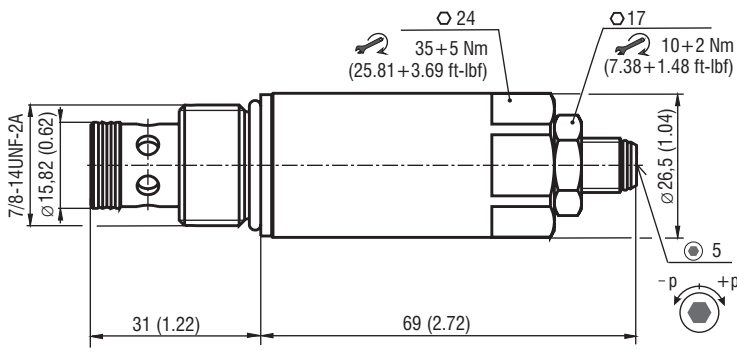

Model T

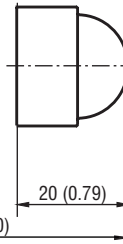

Model RP

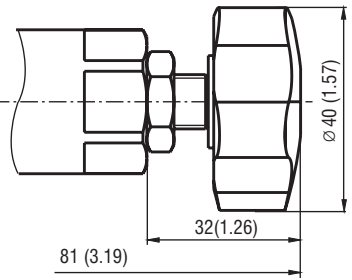

Ordering Code

SR4A-B2 / -

Pressure relief valve, spool-type, pilot-operated
7/8-14 UNF

Model
High performance

Pressure range
up to 63 bar (910 PSI)
up to 100 bar (1450 PSI)
up to 160 bar (2320 PSI)
up to 250 bar (3630 PSI)
up to 350 bar (5080 PSI)

6
10
16
25
35

No designation
V

S
T
RP

Surface treatment
A zinc-coated (ZnCr-3), ISO 9227 (240 h)
B zinc-coated (ZnNi), ISO 9227 (520 h)

Seals
NBR
FPM (Viton)

Adjustment option
allen key (hex. 5), without protective cap
allen key (hex. 5), with protective cap
hand screw, plastic