

4 WAY 2 POSITION ELECTRIC SPOOL VALVE, DIRECT ACTING

- Flow **10 l/min**
- Max working pressure **210 bar**
- Leakage **60 cc/min**
- Seals **NBR and PTFE**
- Cartridge tightening torque **30 Nm**
- Ring nut tightening torque **5 Nm**
- Weight (with coil) **0,35 Kg**
- Cavity **C420000** page 225
- Body **171222** page 190
- Coil (to be ordered separately) **09400** page 179

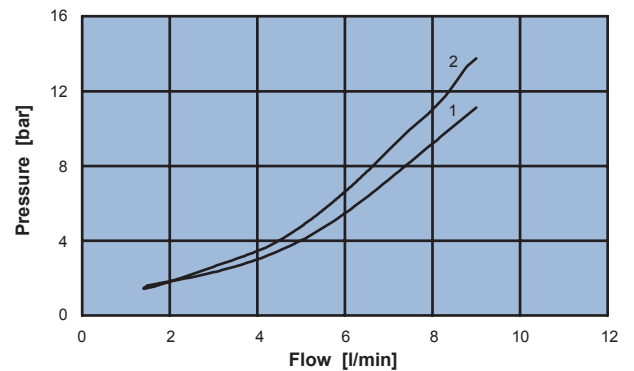

1 = Pressure drop from 2/4 to 3
2 = Pressure drop from 3 to 2/4

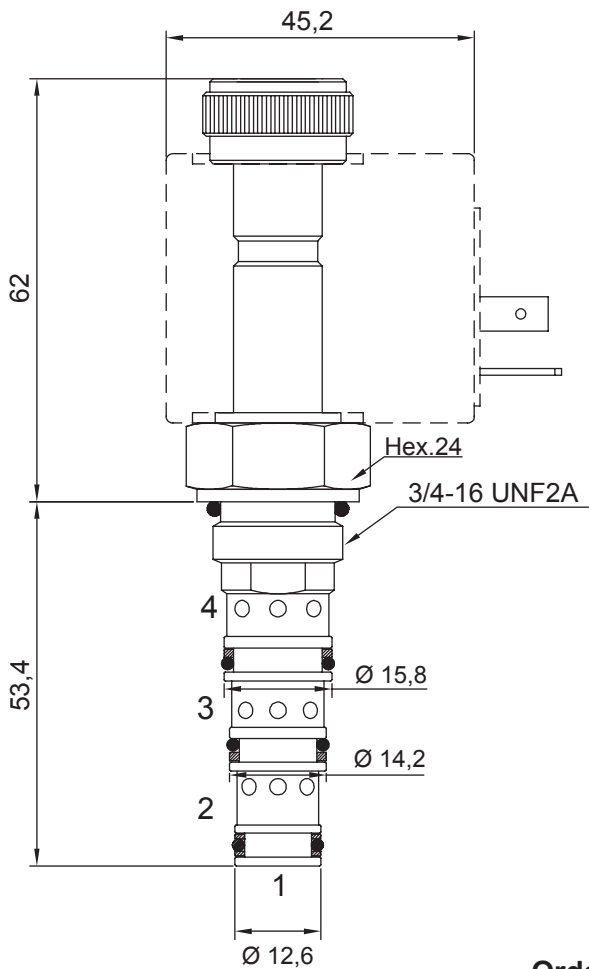
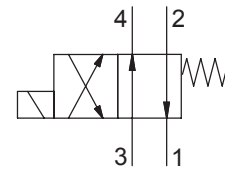
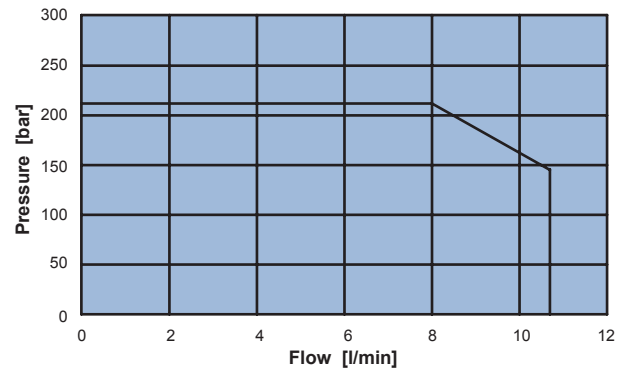

Application limits from 3 in 2/4

Ordering code

0 4 1 2 2 0 0 0 0

