

Pinch valves VZQA

FESTO



Key features

Usage	Design	Areas of application	Examples of flow media:
<ul style="list-style-type: none"> The pinch valve is a 2/2-way valve used to control liquid and powdery media, solids as well as mixtures of substances. 	<ul style="list-style-type: none"> Easy-to-clean housing (clean design) Open or closed in normal position Shut-off element made of elastomer 	<ul style="list-style-type: none"> Filling systems Dosing and weighing systems Powder coating systems Suction and compressed air control units Pneumatic conveying systems Sandblast systems 	<ul style="list-style-type: none"> Granules Powder Dust Liquids containing solids Fibrous products Highly viscous media Abrasive media Corrosive media Paste-like media

Function

The pinch valve is a 2/2-way valve with a tubular pinch sleeve made of elastomer. The free passage when the valve is opened ensures minimum flow resistance and prevents the valve becoming blocked or clogged.

VZQA-C-M22C (normally closed)

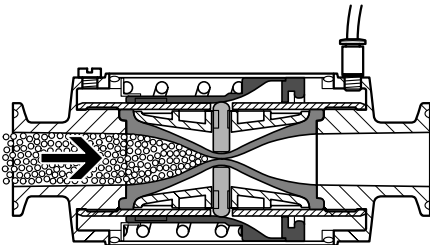

In the normal position, the pinch valve is closed. The pinch valve sleeve opens when the valve is pressurised, releasing the material flow. When pressure is no longer applied, a spring closes the valve. The valve can be used to shut off liquid and gaseous media.

VZQA-C-M22U (normally open)

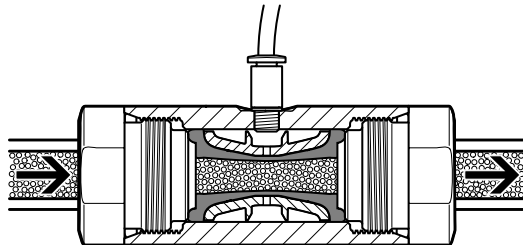

In the normal position, the pinch valve is open. The pinch valve sleeve closes when the valve is pressurised, shutting off the material flow. When pressure is no longer applied, the valve opens due to the inherent stress of the pinch valve sleeve or the pressure of the flow medium. The valve can be used to shut off liquid and powdery media, solids (granules) as well as mixtures of substances.

 **Note**

The hermetic separation between the media circuit and control circuit is no longer guaranteed if wear causes the pinch valve sleeve to leak. The flow medium can then get into the control circuit, from where it can escape. Any potential hazard (e.g. due to aggressive or hot media) must be ruled out. The compressed air supply to the control valve must be protected against the ingress of the flow medium using a suitable check valve, or suitable protection against return flow must be integrated in the pilot line in the immediate vicinity of the media valve. Pilot medium can get into the media circuit if the pinch valve sleeve fails. The media circuit must therefore be sized for the set operating pressure. Any potential hazard must be ruled out.

Product range overview

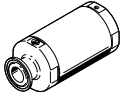
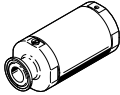
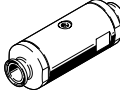
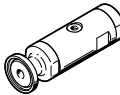
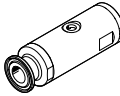
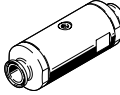
Type		Nominal width DN	Process valve connection	Flow rate [m ³ /h]	Pilot air connection 12, max. permissible screw-in depth	→ Page/Internet
Normally closed M22C						
	VZQA-C-M22C	6	G1/4	0.7	M3, 3 mm	6
			1/4 NPT			
			Clamp ferrule to DIN 32676, series A			
			Clamp ferrule to ASME-BPE, type A			
	VZQA-C-M22C	15	G1/2	5	M5, 5 mm	6
			1/2 NPT			
			Clamp ferrule to DIN 32676, series A			
			Clamp ferrule to ASME-BPE, type A			
	VZQA-C-M22C	25	G1	18	M5, 5 mm	6
			1 NPT			
			Clamp ferrule to DIN 32676, series A			
			Clamp ferrule to ASME-BPE, type B			
Normally open M22U						
	VZQA-C-M22U	6	G1/4	0.7	M5, 4.5 mm	11
			1/4 NPT			
			Clamp ferrule to DIN 32676, series A			
			Clamp ferrule to ASME-BPE, type A			
	VZQA-C-M22U	15	G1/2	5	G1/8, 5 mm	11
			1/2 NPT			
			Clamp ferrule to DIN 32676, series A			
			Clamp ferrule to ASME-BPE, type A			
	VZQA-C-M22U	25	G1	18	G1/8, 6 mm	11
			1 NPT			
			Clamp ferrule to DIN 32676, series A			
			Clamp ferrule to ASME-BPE, type B			

Ordering data – Product options

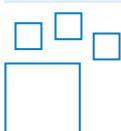

Configurable product
This product and all its product
options can be ordered using the
configurator.

The configurator can be found under
Products on the DVD or at
→ www.festo.com/catalogue/...

Part no.	Type
3174282	VZQA-C-M22C
2037881	VZQA-C-M22U

Peripherals overview

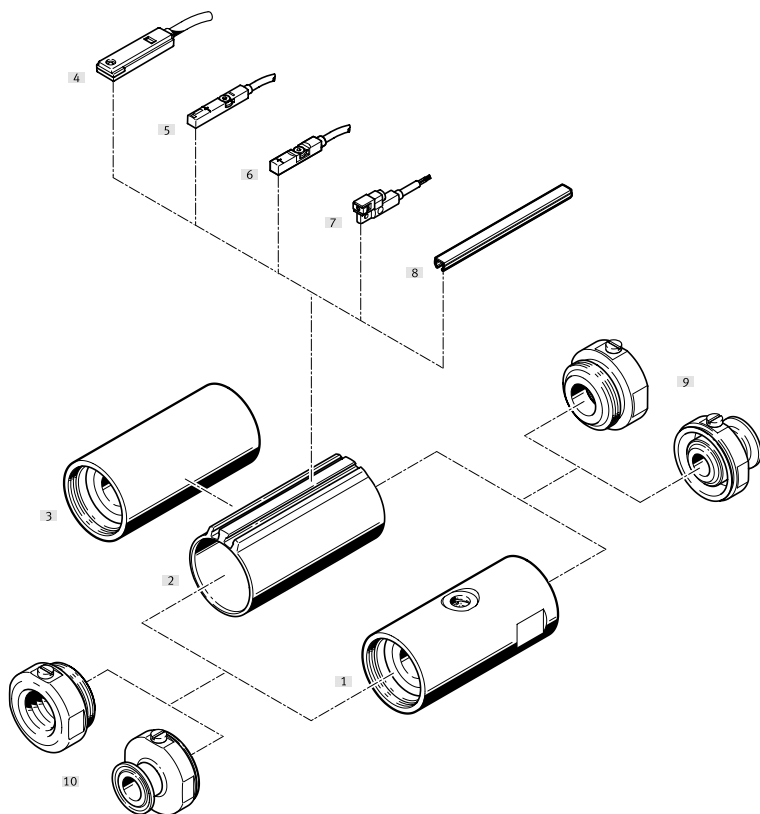

Accessories	Description	→ Page/Internet
Basic body		
[1] Basic body VZQA-C-M22U	Normally open	11
[2] VZQA-C-M22C	<ul style="list-style-type: none"> • Normally closed • “Aluminium housing material” variant (always with T-slots) • Integrated ring magnet only available when “End-position sensing type” is selected 	6
[3] VZQA-C-M22C	<ul style="list-style-type: none"> • Normally closed • “Stainless steel housing material” variant 	
[4] SME-8	Magnetic reed, inserted in the slot lengthwise	
[5] SME-8M	Magnetic reed, inserted in the slot from above	
Proximity switches for T-slot		
[6] SMT-8M	Magnetoresistive, inserted in the slot from above, to EU Explosion Protection Directive	17
[7] SMT-8G	Magnetoresistive, inserted in the slot lengthwise	
[8] Slot cover ABP-5-S	To protect the sensor cables and slots from contamination	18
[9] Port 2	Various connections are available: <ul style="list-style-type: none"> • G female thread • NPT female thread • Clamp ferrule DIN 32676, series A • Clamp ferrule ASME-BPE, type A • Clamp ferrule ASME-BPE, type B 	–
[10] Port 1	Various connections are available: <ul style="list-style-type: none"> • G female thread • NPT female thread • Clamp ferrule DIN 32676, series A • Clamp ferrule ASME-BPE, type A • Clamp ferrule ASME-BPE, type B 	–

Type codes

001	Series
VZQA	Pinch valve, pneumatically actuated

002	Product version
C	Easy-to-clean design

003	Valve function
M22C	2/2-way valve, normally closed
M22U	2/2-way valve, normally open

004	Nominal diameter DN [mm]
6	6
15	15
25	25
50	50

005	Process valve connection type 1
G	G female thread
S1	Clamp ferrule to ASME-BPE, type A
S5	Clamp ferrule to DIN 32676, series A
S12	Clamp ferrule to ASME-BPE, type B
T	NPT female thread

006	Process valve connection type 2
G	G female thread
S1	Clamp ferrule to ASME-BPE, type A
S5	Clamp ferrule to DIN 32676, series A
S12	Clamp ferrule to ASME-BPE, type B
T	NPT female thread

007	Housing material
AL	Aluminium
V2	Stainless steel (nickel-chrome austenitic/1.4301, 1.4303, 1.4306 (AISI 304L))
V4	Stainless steel (chrome-nickel-molybdenum, austenitic/1.4401, 1.4404 (AISI 316L), 1.4408)

008	Housing cover material
AL	Aluminium
V4	Stainless steel
POM	Polyoxymethylene

009	Shut-off element material
E	EPDM
N	NBR
S1	Silicone

010	Pressure range of media
2	0 ... 2 bar
4	0 ... 4 bar
6	0 ... 6 bar
5	0 ... 5 bar

011	Type of sensing
	None
E	End positions

012	Temperature range
	Standard
T28	-5 ... +60 °C

013	Use in a potentially explosive atmosphere
	No
EXA	Assessed for use in an explosive atmosphere

Data sheet M22C



General technical data				
Nominal width DN		6	15	25
Nominal pressure PN of process valve		10		
Design		Pinch valve, pneumatically actuated		
Actuation type		Pneumatic		
Sealing principle		Soft		
Mounting position		Any		
Valve function		2/2-way, closed, monostable		
Flow direction		Reversible		
Reset method		Mechanical spring		
Type of control		Externally piloted		
Type of mounting		In-line installation		
Auxiliary pilot air connection 12		M3	M5	M5
Switching time on	[ms]	125	150	250
Switching time off	[ms]	125	250	400
Flow rate Kv	[m ³ /h]	0.7	5	18
Max. viscosity	[mm ² /s]	4000		

Data sheet M22C

Operating and environmental conditions				
Nominal width DN		6	15	25
Operating pressure				
	[MPa]	0.35 ... 0.6		
	[psi]	49.3 ... 87		
	[bar]	3.5 ... 6		
Burst pressure				
	[MPa]	1.6		
	[psi]	232		
	[bar]	16		
Pressure of medium				
VZQA-C-M22C-...-2	[MPa]	0 ... 0.2		
	[psi]	0 ... 29		
	[bar]	0 ... 2		
VZQA-C-M22C-...-4	[MPa]	0 ... 0.4	–	–
	[psi]	0 ... 58	–	–
	[bar]	0 ... 4	–	–
VZQA-C-M22C-...-5	[MPa]	–	–	0 ... 0.5
	[psi]	–	–	0 ... 72.5
	[bar]	–	–	0 ... 5
VZQA-C-M22C-...-6	[MPa]	–	0 ... 0.6	–
	[psi]	–	0 ... 87	–
	[bar]	–	0 ... 6	–
Ambient temperature	[°C]	–5 ... +60		
Temperature of medium	[°C]	–5 ... +100		
Storage temperature				
For shut-off element EPDM	[°C]	5 ... 20		
For shut-off element VMQ (silicone)	[°C]	5 ... 30		
Food-safe ¹⁾				
For shut-off element EPDM		See supplementary material information ¹⁾		
For shut-off element VMQ (silicone)		See declaration of conformity ¹⁾		
Pilot medium		Compressed air to ISO 8573-1:2010 [7:4:1]		
Medium		Compressed air to ISO 8573-1:2010 [:-:1]		
		Water		

1) Additional information: www.festo.com/catalogue/... → Support/Downloads.

Materials	Material number	
Housing		
V2V4	High-alloy stainless steel	1.4301
ALV4	Wrought aluminium alloy	–
Housing cover	High-alloy stainless steel	1.4404
Bowl		
Nominal width DN6	PPS	
Nominal width DN15	PA6	
Nominal width DN15, process valve connection type S1	PPS	
Nominal width DN25	PPS	
Seals	FPM	
Shut-off element		
VZQA-C-M22C-...-2	VMQ (silicone)	
VZQA-C-M22C-...-4	EPDM	
VZQA-C-M22C-...-6	EPDM	
Note on materials	RoHS-compliant	
PWIS conformity	VDMA24364 zone III	

Data sheet M22C

Dimensions

Download CAD data → www.festo.com

Illustration – connection 1: clamp ferrule to DIN 32676, series A; connection 2: G1/2

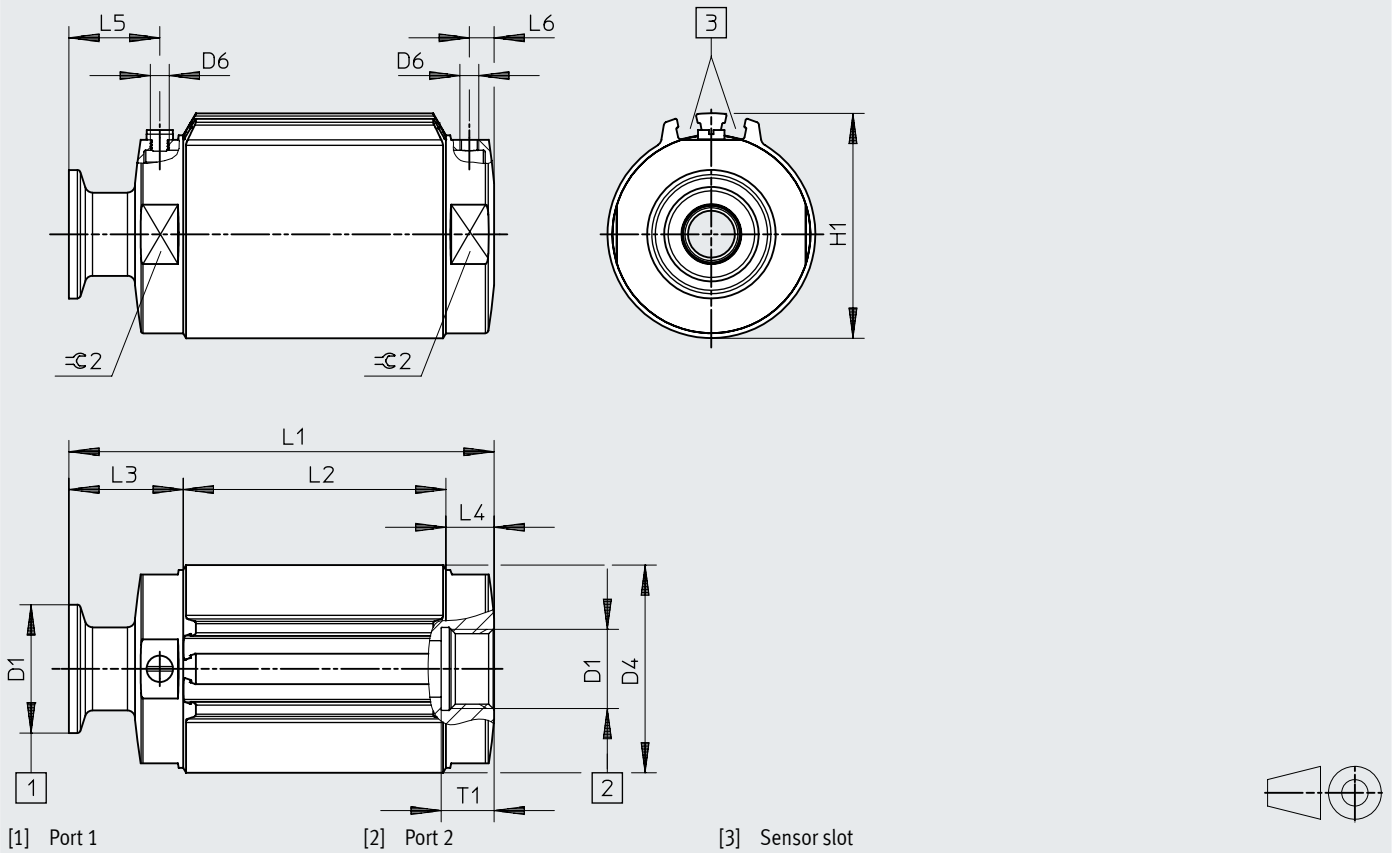



Data sheet M22C

Process valve connection	D1	Material Housing	D4 ∅	D6	H1	L2	L3	L4	L5	L6	T1	≅ 2
Nominal width DN6												
G	G1/4	AL	36	M3	–	47.2	10.9	10.9	4.8	4.8	12	32
G	G1/4	V2	33.6		–		10.9	10.9	4.8	4.8	12	
T	1/4 NPT				41.2		10.9	10.9	4.8	4.8	10	
S5	DIN 32676, series A				–		24	24	17.9	17.9	–	
S1	ASME-BPE, type A				–		24	24	17.9	17.9	–	
Nominal width DN15												
G	G1/2	V2	52.4	M5	59.6	69.5	12.8	12.8	6.6	6.6	14	50
		AL	55		59.6		12.8	12.8	6.6	6.6		
T	1/2 NPT	V2	52.4		59.6		12.8	12.8	6.6	6.6		
		AL	55		59.6		12.8	12.8	6.6	6.6		
S5	DIN 32676, series A	V2	55		–		30.3	30.3	24	24		
S1	ASME-BPE, type A	V2	55	–	30.3	30.3	24	24				
Nominal width DN25												
G	G1	V2	90	M5	94.9	18	18	10	10	18	85	
		AL				18	18	10	10	18		
T	1 NPT	V2				18	18	10	10	18		
		AL				18	18	10	10	18		
S5	DIN 32676, series A	V2				38.5	38.5	30.5	30.5	–		
S1	ASME-BPE, type A	V2	38.5	38.5	30.5	30.5	–					
Process valve combinations						L1						
Nominal width DN6												
GG						69						
GT, TT, TG						69						
S1S1, S1S5, S5S5, S5S1						95.1						
S1G, S1T, GS1, TS1, S5G, S5T, GS5, TS5						82.1						
Nominal width DN15												
GG						95						
GT, TT, TG						95						
S1S1, S1S5, S5S5, S5S1						130						
S1G, S1T, GS1, TS1, S5G, S5T, GS5, TS5						112.5						
Nominal width DN25												
GG						130.8						
GT, TT, TG						130.8						
S1S1, S1S5, S5S5, S5S1						171.9						
S1G, S1T, GS1, TS1, S5G, S5T, GS5, TS5						151.4						

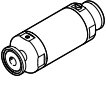
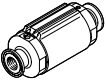
Data sheet M22C

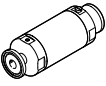
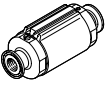
Ordering data						
Pinch valves	Nominal width DN	Process valve connection	Material Shut-off element	Weight [g]	Part no.	Type
	6	G1/4	EPDM	253	8091739	VZQA-C-M22C-6-GG-V2V4E-4
		1/4 NPT		253	4748311	VZQA-C-M22C-6-TT-V2V4E-4
		G1/4	VMQ (silicone)	253	8117024	VZQA-C-M22C-6-GG-V2V4S1-2
		1/4 NPT		256	8117025	VZQA-C-M22C-6-TT-V2V4S1-2
	6	Clamp ferrule to DIN 32676, series A	EPDM	311	8079857	VZQA-C-M22C-6-S5S5-V2V4E-4
		Clamp ferrule to ASME-BPE, type A		302	8079858	VZQA-C-M22C-6-S1S1-V2V4E-4
		Clamp ferrule to DIN 32676, series A	VMQ (silicone)	311	8117022	VZQA-C-M22C-6-S5S5-V2V4S1-2
		Clamp ferrule to ASME-BPE, type A		302	8117023	VZQA-C-M22C-6-S1S1-V2V4S1-2
	6	G1/4	EPDM	137	4748312	VZQA-C-M22C-6-GG-ALALE-4

Ordering data						
Pinch valves	Nominal width DN	Process valve connection	Material Shut-off element	Weight [g]	Part no.	Type
	15	G1/2	EPDM	536	3412426	VZQA-C-M22C-15-GG-V2V4E-6
		G1/2		VMQ (silicone)	549	3412428
		1/2 NPT		549	3412429	VZQA-C-M22C-15-TT-V2V4S1-2
	15	Clamp ferrule to DIN 32676, series A	EPDM	666	3412424	VZQA-C-M22C-15-S5S5-V2V4E-6
		Clamp ferrule to DIN 32676, series A		VMQ (silicone)	655	3412427
		Clamp ferrule to ASME-BPE, type A		611	3412430	VZQA-C-M22C-15-S1S1-V2V4S1-2
With integrated ring magnet for sensing the end positions						
	15	Clamp ferrule to DIN 32676, series A	EPDM	607	3412425	VZQA-C-M22C-15-S5S5-ALV4E-6-E

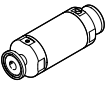
Ordering data						
Pinch valves	Nominal width DN	Process valve connection	Material Shut-off element	Weight [g]	Part no.	Type
	25	G1	EPDM	2068	8159108	VZQA-C-M22C-25-GG-V2V4E-5-T28
				VMQ (silicone)	8159105	VZQA-C-M22C-25-GG-V2V4S1-2
			EPDM	1186	8159107	VZQA-C-M22C-25-GG-ALALE-5-T28
	25	Clamp ferrule to DIN 32676, series A	EPDM	2354	8159106	VZQA-C-M22C-25-S5S5-V2V4E-5
					VMQ (silicone)	8159104

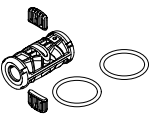
Ordering data								
Seal cartridge	Nominal width DN	Storage temperature [°C]	Shut-off element material	PWIS conformity	Note on materials	Food-safe	Part no.	Type
	6	5 ... 20	EPDM	VDMA24364-B2-L	RoHS-compliant	1)	3418620	VAVC-Q2-M22C-6-E
		5 ... 30	VMQ (silicone)	VDMA24364 zone III		2)	8119890	VAVC-Q2-M22C-6-S1
	15	5 ... 20	EPDM	VDMA24364-B2-L		1)	3418619	VAVC-Q2-M22C-15-E
		5 ... 30	VMQ (silicone)	VDMA24364 zone III		2)	8117430	VAVC-Q2-M22C-15-S1
	25	5 ... 20	EPDM	VDMA24364-B2-L		1)	8161070	VAVC-Q-M22C-25-E
		5 ... 30	VMQ (silicone)	VDMA24364 zone III		2)	8161063	VAVC-Q-M22C-25-S1

1) See supplementary material information

Additional information: www.festo.com/catalogue/... → Support/Downloads.

2) See declaration of conformity

Data sheet M22U



General technical data					
Nominal width DN		6	15	25	50
Nominal pressure PN of process valve	10				
Design	Pinch valve, pneumatically actuated				
Actuation type	Pneumatic				
Sealing principle	Soft				
Mounting position	Any				
Valve function	2/2-way, monostable, open				
Flow direction	Reversible				
Reset method	Rebound resilience				
Type of control	Externally piloted				
Type of mounting	In-line installation				
Auxiliary pilot air connection 12	M5	G1/8	G1/8	G1/8	
Switching time on [ms]	125	250	250	200	
Switching time off [ms]	125	250	250	1000	
Flow rate Kv [m ³ /h]	0.7	5	18	72	
Max. viscosity [mm ² /s]	4000				

Materials				
VZQA-C-M22U-...	V4V4	ALAL	ALV4	ALPOM
Housing	High-alloy stainless steel	Wrought aluminium alloy		
Material number of housing	1.4404	-		
Housing cover	High-alloy stainless steel	Wrought aluminium alloy	High-alloy stainless steel	POM
Bowl	PA6			
Seals	FPM			
Note on materials	RoHS-compliant			
PWIS conformity	VDMA24364 zone III			
Suitable for the production of Li-ion batteries	Metals with more than 1% copper, zinc or nickel by mass are excluded from use. Exceptions are nickel in steel, chemically nickel-plated surfaces, circuit boards, cables, electrical plug connectors and coils			

Data sheet M22U

Operating and environmental conditions		6	15	25	50
Nominal width DN					
Operating pressure					
	[MPa]	0.1 ... 0.65			0 ... 0.45
	[psi]	14.5 ... 94.3			0 ... 65.25
	[bar]	1 ... 6.5			0 ... 4.5
Overload pressure					
	[MPa]	0.78			
	[psi]	113.1			
	[bar]	7.8			
Pressure of medium					
	[MPa]	0 ... 0.4			0 ... 0.2
	[psi]	0 ... 58			0 ... 29
	[bar]	0 ... 4			0 ... 2
Burst pressure					
	[MPa]	1.6			
	[psi]	232			
	[bar]	16			
Differential pressure					
For shut-off element NBR, EPDM	[MPa]	0.25			
	[psi]	36.25			
	[bar]	2.5			
For shut-off element VMQ (silicone)	[MPa]	0.25	0.3	-	
	[psi]	36.25	43.5	-	
	[bar]	2.5	3	-	
Ambient temperature					
	[°C]	-5 ... +60			
Storage temperature					
For shut-off element NBR, EPDM	[°C]	5 ... 20			
For shut-off element VMQ (silicone)	[°C]	5 ... 30			-
Pilot medium					
For shut-off element EPDM	Compressed air to ISO 8573-1:2010 [7:4:1]				
For shut-off element NBR, VMQ (silicone)	Compressed air to ISO 8573-1:2010 [7:4:4]				-
Medium					
For shut-off element EPDM	Compressed air to ISO 8573-1:2010 [:-:1]				
	Water				
For shut-off element NBR, VMQ (silicone)	Compressed air to ISO 8573-1:2010 [:-:~]				-
Temperature of medium					
For shut-off element NBR	[°C]	-5 ... +60			-
For shut-off element EPDM	[°C]	-5 ... +100			-
For shut-off element VMQ (silicone)	[°C]	-5 ... +150			-
Food-safe					
For shut-off element EPDM	See supplementary material information ¹⁾				
For shut-off element VMQ (silicone)	See declaration of conformity ¹⁾				-
For shut-off element NBR	-				-

1) Additional information: www.festo.com/catalogue/... → Support/Downloads.

Data sheet M22U

Dimensions

Download CAD data → www.festo.com

Illustration – connection 1: clamp ferrule to DIN 32676, series A; connection 2: G1/2

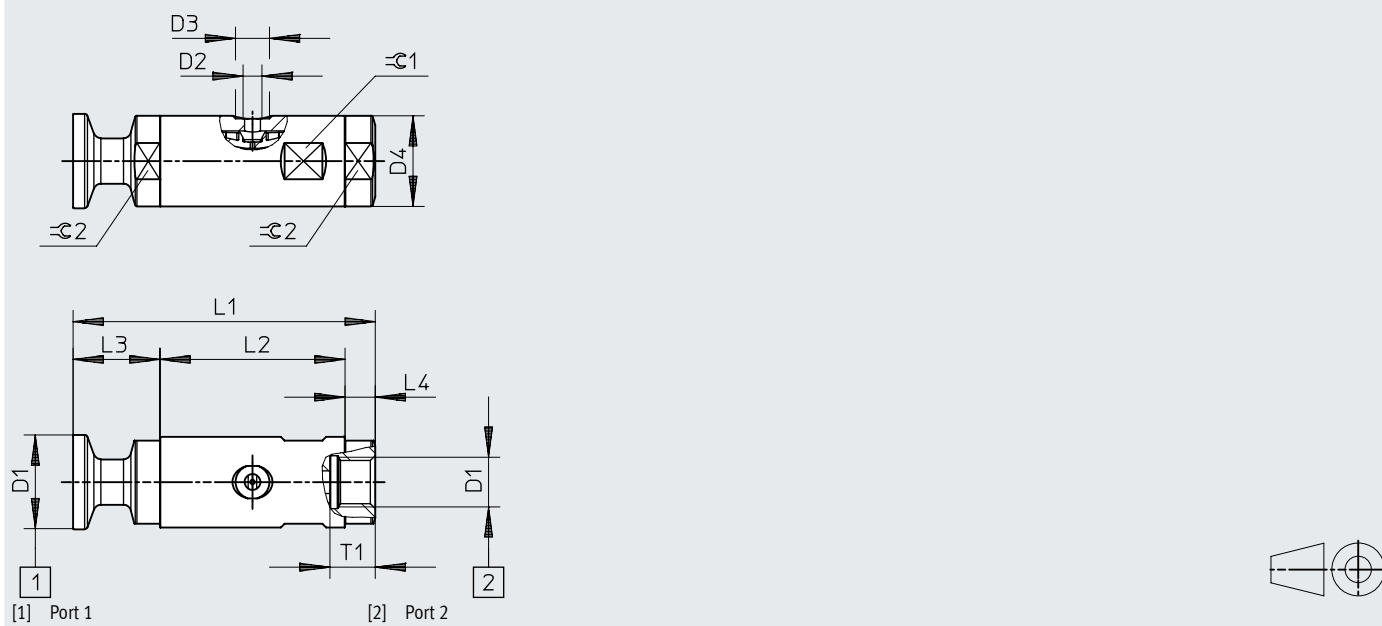

Data sheet M22U

Process valve connection	D1	Material Housing cover	D2	D3 ∅	D4 ∅	L2	L3	L4	T1	≙ 1	≙ 2
Nominal width DN6											
G	G1/4	V4, AL	M5	9	24	49	8	8	12	22	22
T	1/4 NPT	V4, AL					8	8			
S5	DIN 32676, series A	V4					23	23			
S1	ASME-BPE, type A	V4					23	23			
Nominal width DN15											
G	G1/2	V4, AL	G1/8	15	38	81	7	7	14	36	36
		POM					12	12			
T	1/2 NPT	V4, AL					7	7			
		POM					12	12			
S5	DIN 32676, series A	V4	24.5	24.5							
S1	ASME-BPE, type A	V4	24.5	24.5							
Nominal width DN25											
G	G1	V4, AL	G1/8	15	58	109	10.5	10.5	18	55	55
		POM					15.5	15.5			
T	1 NPT	V4, AL					10.5	10.5			
		POM					15.5	15.5			
S5	DIN 32676, series A	V4	28	28							
S1	ASME-BPE, type A	V4	28	28							
S12	ASME-BPE, type B	V4	28	28							
Nominal width DN50											
G	G2	V4, AL	G1/8	15	88	150	15	15	22	85	85
		POM					15	15			
T	2 NPT	V4, AL					15	15			
		POM					15	15			
S5	DIN 32676, series A	V4	29	29							
S1	ASME-BPE, type A	V4	29	29							
S12	ASME-BPE, type B	V4	29	29							
Process valve combinations			L1								
			Nominal width DN6	Nominal width DN15	Nominal width DN25	Nominal width DN50					
GG, GT, TT, TG made of V4 or AL			65	95	130	180					
GG, GT, TT, TG made of POM			-	105	140	-					
GG, GT, TT, TG made of V4 or AL with POM			-	100	135	-					
S1S1, S1S5, S5S5, S5S1, S1S12, S12S1, S5S12, S12S5, S12S12			80	130	165	-					
S1G, S1T, GS1, TS1, S5G, S5T, GS5, TS5, S12G, S12T, GS12, TS12			95	112.5	147.5	-					
S5S5, S5S12, S12S5, S12S12			-	-	-	208					
S5G, S5T, GS5, TS5, S12G, S12T, GS12, TS12			-	-	-	194					

Data sheet M22U

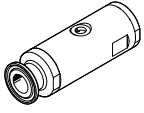
Ordering data								
Pinch valve	Nominal width DN	Suitable for the production of Li-ion batteries	Process valve connection	Material Shut-off element	Weight [g]	Part no.	Type	
	6	F1A	G1/4	NBR	105.5	2931679	VZQA-C-M22U-6-GG-ALV4N-4	
				EPDM	157	2931678	VZQA-C-M22U-6-GG-V4V4E-4	
				EPDM	163	2931686	VZQA-C-M22U-6-GG-V4V4E-4-EXA	
				Silicone	157	2931683	VZQA-C-M22U-6-GG-V4V4S1-4	
			1/4 NPT	Silicone	157	2931685	VZQA-C-M22U-6-TT-V4V4S1-4	
			Clamp ferrule to DIN 32676, series A	EPDM	215	2931681	VZQA-C-M22U-6-S5S5-V4V4E-4	
				Silicone	215	2931682	VZQA-C-M22U-6-S5S5-V4V4S1-4	
			Clamp ferrule to ASME-BPE, type A	Silicone	195	2931684	VZQA-C-M22U-6-S1S1-V4V4S1-4	
			15	G1/2	NBR	431	3022830	VZQA-C-M22U-15-GG-V4V4N-4
					NBR	265	3022831	VZQA-C-M22U-15-GG-ALV4N-4
					NBR	158	3022832	VZQA-C-M22U-15-GG-ALPOMN-4
					EPDM	431	3022829	VZQA-C-M22U-15-GG-V4V4E-4
	EPDM	453			3022839	VZQA-C-M22U-15-GG-V4V4E-4-EXA		
	Silicone	431			3022835	VZQA-C-M22U-15-GG-V4V4S1-4		
	1/2 NPT	Silicone		431	3022838	VZQA-C-M22U-15-TT-V4V4S1-4		
	Clamp ferrule to DIN 32676, series A	EPDM		559	3022833	VZQA-C-M22U-15-S5S5-V4V4E-4		
		Silicone		559	3022834	VZQA-C-M22U-15-S5S5-V4V4S1-4		
	Clamp ferrule to ASME-BPE, type A	Silicone		495	3022837	VZQA-C-M22U-15-S1S1-V4V4S1-4		
	25	G1		EPDM	1178	3968922	VZQA-C-M22U-25-GG-V4V4E-4	
				EPDM	480	3968923	VZQA-C-M22U-25-GG-ALALE-4	
			EPDM	1227	3968929	VZQA-C-M22U-25-GG-V4V4E-4-EXA		
			Silicone	1178	3968926	VZQA-C-M22U-25-GG-V4V4S1-4		
		1 NPT	Silicone	1178	3968928	VZQA-C-M22U-25-TT-V4V4S1-4		
		Clamp ferrule to DIN 32676, series A	EPDM	1474	3968924	VZQA-C-M22U-25-S5S5-V4V4E-4		
			Silicone	1474	3968925	VZQA-C-M22U-25-S5S5-V4V4S1-4		
		Clamp ferrule to ASME-BPE, type B	Silicone	1516	3968927	VZQA-C-M22U-25-S1S12-V4V4S1-4		
		50	G2	EPDM	2090	8161475	VZQA-C-M22U-50-GG-ALV4E-2	
			G2	EPDM	2090	8172745	VZQA-C-M22U-50-GG-V2V4E-2	
G2			EPDM	1302	8161473	VZQA-C-M22U-50-GG-ALALE-2		
2 NPT			EPDM	2090	8161476	VZQA-C-M22U-50-TT-ALV4E-2		
2 NPT	EPDM		1302	8161477	VZQA-C-M22U-50-TT-ALALE-2			
Clamp ferrule to DIN 32676, series A	EPDM		2432	8161474	VZQA-C-M22U-50-S5S5-ALV4E-2			

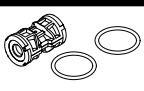
Ordering data								
Seal cartridge	Nominal width DN	Material Shut-off element	Storage temperature [°C]	PWIS conformity	Note on materials	Food-safe	Part no.	Type
	6	NBR	5 ... 20	VDMA24364-B2-L	RoHS-compliant	–	2392881	VAVC-Q2-M22U-6-N
		EPDM				1)	2392882	VAVC-Q2-M22U-6-E
		EPDM				1)	2392884	VAVC-Q2-M22U-6-E-EXA
		VMQ (silicone)				2)	2392883	VAVC-Q2-M22U-6-S1
	15	NBR	5 ... 20	VDMA24364-B2-L	RoHS-compliant	–	3019151	VAVC-Q2-M22U-15-N
		EPDM				1)	3019148	VAVC-Q2-M22U-15-E
		EPDM				1)	3019152	VAVC-Q2-M22U-15-E-EXA
		VMQ (silicone)				2)	3019144	VAVC-Q2-M22U-15-S1
	25	NBR	5 ... 20	VDMA24364-B2-L	RoHS-compliant	–	3970092	VAVC-Q2-M22U-25-N
		EPDM				1)	3970093	VAVC-Q2-M22U-25-E
		EPDM				1)	3970095	VAVC-Q2-M22U-25-E-EXA
		VMQ (silicone)				2)	3970094	VAVC-Q2-M22U-25-S1
	50	EPDM	5 ... 20	VDMA24364-B2-L	RoHS-compliant	1)	8174147	VAVC-Q2-M22U-50-E



- 1) See supplementary material information
Additional information: www.festo.com/catalogue/... → Support/Downloads.
- 2) See declaration of conformity

Ordering data – Modular product system



Ordering table					
VZQA-C-...	M22C	M22U	Conditions	Code	Enter code
Module no.	3174282	2037881			
Product type	Pinch valve			VZQA	VZQA
Design	Easy-to-clean design			-C	-C
Valve function	2/2-way valve, normally closed	–		-M22C	
	–	2/2-way valve, normally open		-M22U	
Nominal diameter DN	6			-6	
	15			-15	
	25			-25	
	–	50	[11]	-50	
Process valve connection type 1	G female thread			-G	
	Clamp ferrule to ASME-BPE, type A		[1] [4]	-S1	
	Clamp ferrule to DIN 32676, series A		[1]	-S5	
	NPT female thread			-T	
	Clamp ferrule to ASME-BPE, type B		[1] [3] [4] [6]	-S12	
Process valve connection type 2	G female thread			G	
	Clamp ferrule to ASME-BPE, type A		[1] [4]	S1	
	Clamp ferrule to DIN 32676, series A		[1]	S5	
	NPT female thread			T	
	Clamp ferrule to ASME-BPE, type B		[1] [3] [4] [6]	S12	
Housing material	Aluminium			-AL	
	Stainless steel (austenitic chromium-nickel)	–		-V2	
	–	Stainless steel (austenitic chromium-nickel-molybdenum)		-V4	
Housing cover material	Aluminium			AL	
	–	Polyoxymethylene	[3]	POM	
	Stainless steel (austenitic chromium-nickel-molybdenum)			V4	
Shut-off element material	EPDM			E	
	–	NBR		N	
	–	Silicone		S1	
Pressure range of media [bar]	0 ... 2	–	[8]	-2	
	0 ... 4		[7]	-4	
	0 ... 6	–	[3]	-6	
Sensing type	None				
	End positions		[2] [5]	-E	
Temperature range [°C]	Standard				
	–5 ... +60		[10]	-T28	
Use in potentially explosive atmospheres	No				
	Rated for use in explosive atmospheres		[9]	-EXA	

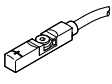
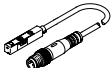
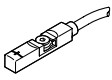

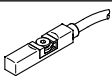
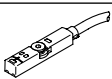
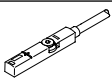
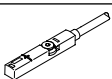
- [1] S1, S5, S12 Only in combination with housing cover material V4 (stainless steel)
- [2] E Only in combination with valve function M22C
- [3] POM, S12, 6 Not in combination with nominal diameter DN6
- [4] S1, S12 Not in combination with nominal diameter DN25 with valve function M22C
- [5] E Not in combination with housing material V2 (stainless steel)
- [6] S12 Not in combination with nominal diameter DN15
- [7] 4 Not in combination with nominal diameter DN15 with valve function M22C
- [8] 2 S1 with M22C only in combination with 2 bar
- [9] EXA Only in combination with housing material V4 and housing cover material V4
- [10] T28 Only in combination with shut-off element material EPDM
- [11] DN50 Not in combination with EXA

Accessories

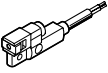
Ordering data – Proximity switches for T-slot, magnetoresistive							Data sheets → Internet: smt-8
	Switching output	Electrical connection			Cable length [m]	Part no.	Type
		Cable	Cable with plug, rotatable thread				
			M8x1	M12x1			
N/O							
	PNP	–	3-pin	–	0.3	574334	SMT-8M-A-PS-24V-E-0.3-M8D
		3-wire	–	–	2.5	574335	SMT-8M-A-PS-24V-E-2.5-OE
		3-wire	–	–	5	574336	SMT-8M-A-PS-24V-E-5.0-OE
		–	–	3-pin	0.3	574337	SMT-8M-A-PS-24V-E-0.3-M12
	NPN	3-wire	–	–	2.5	574338	SMT-8M-A-NS-24V-E-2.5-OE
–		3-pin	–	0.3	574339	SMT-8M-A-NS-24V-E-0.3-M8D	
	PNP	–	3-pin	–	0.3	8059120	SDBT-MSX-1L-PU-E-0.3-N-M8
N/O contact, corrosion-resistant							
	PNP	3-wire	–	–	5	574380	CRSMT-8M-PS-24V-K-5.0-OE
		3-wire	–	–	10	574381	CRSMT-8M-PS-24V-K-10.0-OE
	PNP	–	–	3-pin	0.3	574382	CRSMT-8M-PS-24V-K-0.3-M12
		–	3-pin	–	0.3	574383	CRSMT-8M-PS-24V-K-0.3-M8D
N/C contact							
	PNP	3-wire	–	–	7.5	574340	SMT-8M-A-PO-24V-E-7.5-OE
Switchable							
	PNP/NPN	–	3-pin	–	0.3	574343	SMT-8M-A-PNS-24V-E-0.3-M8D
	PNP PS/PO	–	3-pin	–	0.3	574344	SMT-8M-A-PSO-24V-E-0.3-M8D
Ordering data – Proximity switch for T-slot, magnetic reed							Data sheets → Internet: sme-8
	Switching output	Electrical connection			Cable length [m]	Part no.	Type
		Cable	Cable with plug, rotatable thread				
			M8x1				
N/O							
	Contacting, bipolar	–	3-pin	–	0.3	543861	SME-8M-DS-24V-K-0.3-M8D
		3-wire	–	–	2.5	543862	SME-8M-DS-24V-K-2.5-OE
		3-wire	–	–	5	543863	SME-8M-DS-24V-K-5.0-OE
		2-wire	–	–	2.5	543872	SME-8M-ZS-24V-K-2.5-OE
		3-wire	–	–	7.5	543876	SME-8M-DS-24V-K-7.5-OE
N/C contact							
	Contacting, bipolar	3-wire	–	–	7.5	546799	SME-8M-DO-24V-K-7.5-OE

Accessories

Ordering data – Proximity switches for T-slot, magnetoresistive						Data sheets → Internet: smt-8
	Switching output	Electrical connection		Cable length [m]	Part no.	Type
		Cable	Plug M8x1			
N/O						
	PNP	3-wire	–	2.5	547859	SMT-8G-PS-24V-E-2.5Q-OE
		–	3-pin	0.3	547860	SMT-8G-PS-24V-E-0.3Q-M8D
	PNP	–	3-pin	–	562019	SMT-8-SL-PS-LED-24-B

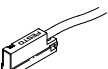
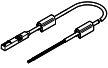
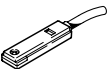
Ordering data – Proximity switch for T-slot, magnetic reed						Data sheets → Internet: sme-8
	Switching output	Electrical connection		Cable length [m]	Part no.	Type
		Cable	Plug M8x1			
N/O						
	Contacting, bipolar	3-wire	–	2.5	150855	SME-8-K-LED-24
		3-wire	–	5.0	175404	SME-8-K5-LED-24
		3-wire	–	7.5	530491	SME-8-K-7.5-LED-24
		–	3-pin	0.3	150857	SME-8-S-LED-24
		2-wire	–	2.5	171169	SME-8-ZS-KL-LED-24
	Contacting, bipolar, heat-resistant	2-wire	–	2.5	161756	SME-8-K-24-S6
	Contacting, bipolar, operating voltage range up to 230 V AC/DC	2-wire	–	2.5	152820	SME-8-K-LED-230
	Contacting, bipolar	3-wire	–	2.5	543862	SME-8M-DS-24V-K-2.5-OE
		2-wire	–	2.5	543872	SME-8M-ZS-24V-K-2.5-OE
N/C contact						
	Contacting, bipolar	3-wire	–	7.5	160251	SME-8-O-K-LED-24

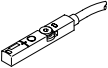
Ordering data – Position transmitter for T-slot, Magnetic Hall						Data sheets → Internet: sdas
	Switching output	Electrical connection		Cable length [m]	Part no.	Type
		Cable	Plug M8x1			
	2x PNP or 2x NPN, adjustable	–	4-pin	0.3	8063974	SDAS-MHS-M40-1L-PNLK-PN-E-0.3-M8
		4-wire	–	2.5	8063975	SDAS-MHS-M40-1L-PNLK-PN-E-2.5-LE

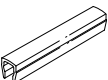
Ordering data – Slot cover for T-slot				
	Mounting	Length [m]	Part no.	Type
	Insertable	2x 0.5	151680	ABP-5-S