

Proportional Directional Control Spool Valve

**PRM2-04**

Size 04 (D02) •  $Q_{max}$  20 l/min (5 GPM) •  $p_{max}$  320 bar (4600 PSI)



**Technical Features**

- › Proportional directional control spool valve with subplate mounting surface acc. to ISO 4401 (size 04) and DIN 24340 (CETOP 02)
- › The valve is designed for control of movement direction of actuator and continuous speed regulation in the given range
- › The volumetric flow through the valve is proportional to the electrical input command signal
- › Valve control with the help of external or internal electronic control unit (ECU) in the form of connector plug
- › Manual override of valve spool
- › Optional type of electric connector for the valve without integrated ECU
- › Adjustable position of coil connector suitable for mounting, achievable by turning the coil after loosening the fastening nut
- › In the standard version, the valve housing is phosphated for basic surface corrosion protection and as preparation for painting. Steel parts are zinc-coated for 240 h salt spray protection acc. to ISO 9227
- › Enhanced surface protection for mobile sector available for the valve housing and steel parts (ISO 9227, 520 h salt spray)

**Popis funkce**

The proportional directional control spool valve is designed to control the movement direction (double solenoid valve), stop, control the speed and position of the piston rod of hydraulic cylinder or shaft of hydraulic motor. The speed of movement is proportional to the volumetric flow through the valve, which is continuously regulated by throttling at the control edges of spool, proportionally to the input command signal. An electronic control unit (ECU) EL7 is used for the valve control. The ECU converts the input command signal into an output current control PWM signal for solenoid coils. The ECU EL7 is available as external for connection to the DIN rail (EL7-E, see datasheet HA 9152) or integrated on the valve in the form of connector plug (EL7-I, see datasheet HA 9151).

**Technical Data**

ISO 4401-02-01-0-05

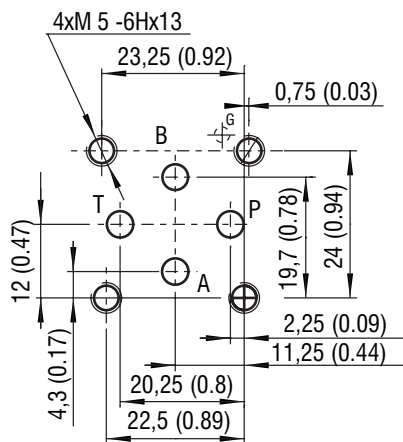

Ports P, A, B and T - max.  $\varnothing$ 4.5 mm (0.18 in)

Valve size	04 (D02)	
Max. operating pressure at port P, A, B	bar (PSI)	320 (4580)
Max. operating pressure at port T	bar (PSI)	210 (3050)
Fluid temperature range (NBR)	°C (°F)	-30 ... +80 (-22 ... +176)
Fluid temperature range (FPM)	°C (°F)	-20 ... +80 (-4 ... +176)
Ambient temperature range	°C (°F)	-30 ... +50 (-22 ... +122)
Hysteresis	%	≤ 6
Nominal flow rate $Q_n$ at $\Delta p=10$ bar (145 PSI)	l/min (GPM)	4 (1.1) 8 (2.1) 12 (3.2)
Min. protection degree acc. to EN 60529 (see page 4 - coil types)		IP65
Weight - valve with 1 solenoid - valve with 2 solenoids	kg (lbs)	0.9 (1.98) 1.25 (2.76)
Technical data of proportional solenoid		
Nominal supply voltage	V DC	12 24
Limit current	A	1.7 0.8
Mean resistance value at 20 °C (68 °F)	Ω	5 21
Technical data of electronic control unit EL-7		
Operating supply voltage $U_{cc}$	V DC	9 ... 32
Reference voltage $U_{ref}$	V DC	5
Max. current at $U_{ref}$	mA	20
Types of input command signal, when EL7 is used		see datasheet EL7*
Max. output current / 1 coil	A	3
PWM frequency	Hz	80 ... 1 000
Resolution of A/D converters	bit	12
Ramp function	s	0 ... 45
Dither – amplitude*	% from $I_{max}$	0 ... 30
Dither – frequency*	Hz	60 ... 300
* When the dither is activated, the PWM frequency is automatically set to 15 kHz		
		Datasheet
General information	GI_0060	products and operating conditions
Coil types / Connectors	C_8007 / K_8008	C 19B* / K*
Mounting interface	SMT_0019	Size 04
Spare parts	SP_8010	
Subplates	DP_0002	DP*-04

Objednáací klíč

PRM2-04 / - - - - -

Proportional directional control spool valve

Valve size

Spool symbols see table „Spool Symbols“

Nominal flow rate at  $\Delta p=10$  bar (145 PSI)  
4 l/min (1.05 GPM) **04**  
8 l/min (2.1 GPM) **08**  
12 l/min (3.2 GPM) **12**

Rated supply voltage of solenoid (at the coil terminal)  
Without solenoid coil (type without integrated ECU only) **00**  
12 V DC **12**  
24 V DC **24**

Integrated electronic control unit (standardly on the solenoid „a“)  
Electronic control unit EL7-IA with an analogue input command signal **EL7-A**  
Electronic control unit EL7-IC for connection to the CAN bus **EL7-C**

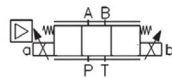

No designation  
A zinc-coated (ZnCr-3), ISO 9227 (240 h)  
B zinc-coated (ZnNi), ISO 9227 (520 h)

Surface treatment  
standard  
zinc-coated (ZnCr-3), ISO 9227 (240 h)  
zinc-coated (ZnNi), ISO 9227 (520 h)

No designation  
V

Seals  
NBR  
FPM (Viton)

No designation  
N2

Manual override  
standard (operated by pin)  
rubber boot protected

No designation  
K1

Connector plug acc. to EN 175301-803-A  
valve with integrated electronic control unit  
connector plug EN 175301-803-A without rectifier for the valve  
without integrated ECU and with coils E1 or E2

Connector  
(only for valves without EL7-I)  
EN 175301-803-A

- E1 EN 175301-803-A
- E2 E1 with quenching diode
- E3 AMP Junior Timer - radial direction (2 pins; male)
- E4 E3 with quenching diode
- E3A AMP Junior Timer - axial direction (2 pins; male)
- E4A E3A with quenching diode
- E8 loose conductors (two insulated wires)
- E9 E8 with quenching diode
- E12A Deutsch DT04-2P - axial direction (2 pins; male)
- E13A E12A with quenching diode

- For proportional valves with two solenoids, single solenoid must be de-energized before the other solenoid can be charged.
- Mounting bolts M5 x 35 DIN 912-10.9 or studs must be ordered separately. Tightening torque is 5+1 Nm (3.7+0.7 lbf.ft).
- Besides the shown, commonly used valve versions other special models are available.
- Contact our technical support for their identification, feasibility and operating limits.

Spool Symbols

Type	Symbol	Type	Symbol	Type	Symbol
2Z51		3Z11		3Z21	$\frac{Q_a}{Q_b} = \frac{2^*}{1}$
2Z11		3Z12	$\frac{Q_a}{Q_b} = \frac{1^*}{2}$	3Y21	$\frac{Q_a}{Q_b} = \frac{2^*}{1}$
2Y51		3Y11		*Model for cylinders with asymmetric piston area ratio	
2Y11		3Y12	$\frac{Q_a}{Q_b} = \frac{1^*}{2}$		

Characteristics measured at  $v = 32$  mm<sup>2</sup>/s (156 SUS)

Operating limits: Flow direction P → A / B → T or P → B / A → T

Nominal flow 4 l/min (1.1 GPM)

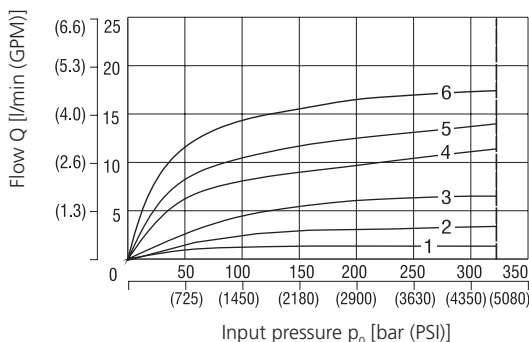

Nominal flow 8 l/min (2.1 GPM)

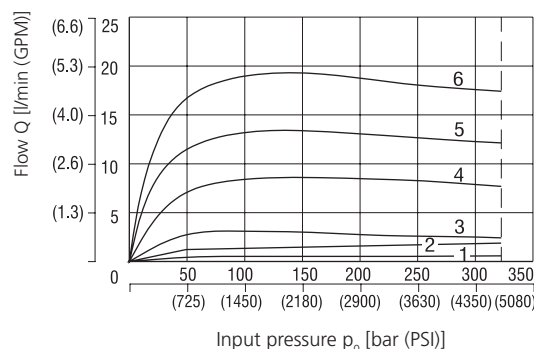

- Solenoid current:
- 1 = 50 %
  - 2 = 60 %
  - 3 = 70 %
  - 4 = 80 %
  - 5 = 90 %
  - 6 = 100 %

**Characteristics** measured at  $v = 32 \text{ mm}^2/\text{s}$  (156 SUS)

Nominal flow 12 l/min (3.2 GPM)

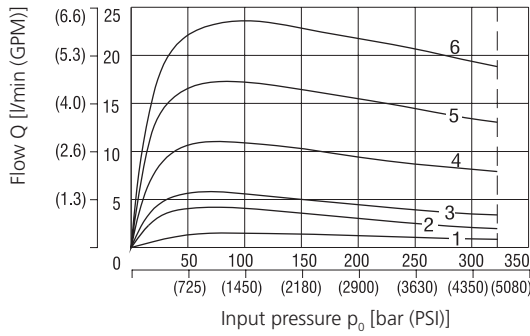

**Solenoid current:**

- 1 = 50%
- 2 = 60%
- 3 = 70%
- 4 = 80%
- 5 = 90%
- 6 = 100%

**Regulated flow related to control signal**  $\Delta p = 10 \text{ bar}$  (145 PSI)

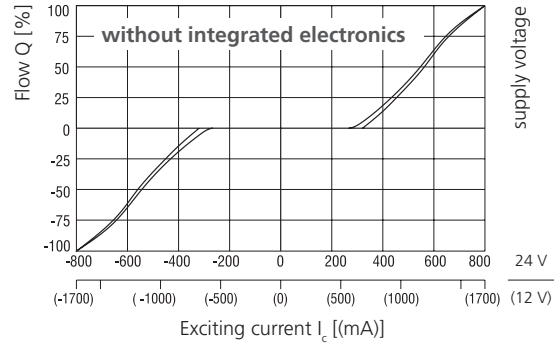
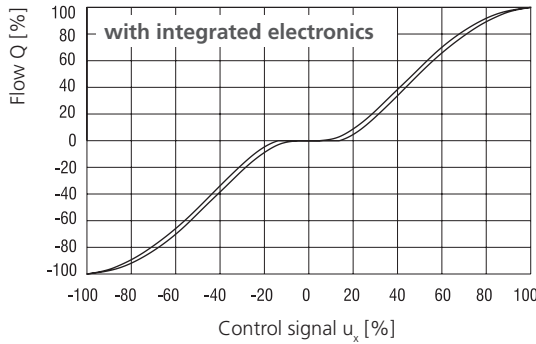

The coil current which initializes the flow through the proportional directional valve can differ due to the production tolerances about in a range of  $\pm 6\%$  of the limit current.

**Transient Characteristic** measured at  $v = 32 \text{ mm}^2/\text{s}$  (156 SUS),  $\Delta p = 10 \text{ bar}$  (145 PSI)

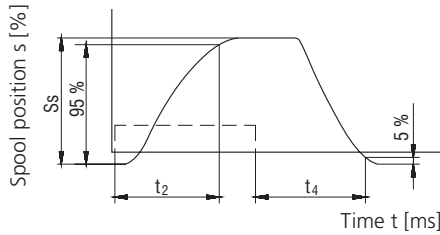

Steady Spool Position $S_s$ [%]	$t_2$ [ms]	$t_4$ [ms]
100	85	100
75	70	85
50	55	75
25	45	55

---- the control signal course of the integrated electronics

The values in table have only an informative character. The times of the transient characteristics at pressure or flow control will be in a particular hydraulic circuit always longer.

**Frequency Response**

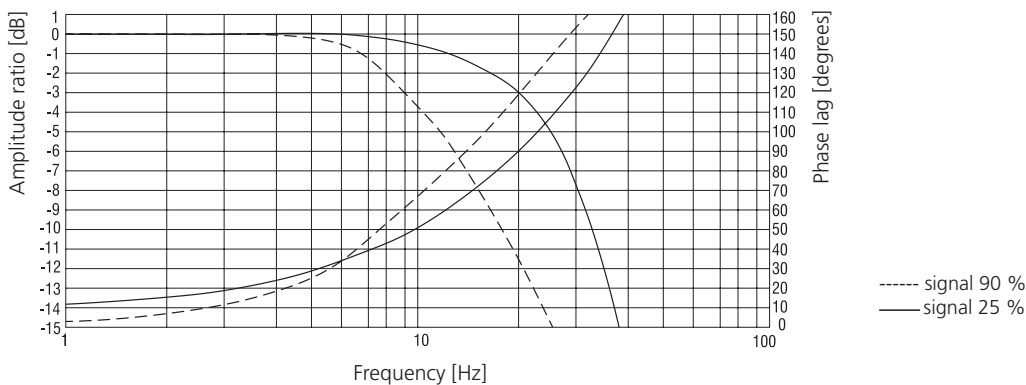

**Electronic control unit EL7**

The ECU EL7 allows direct independent control of the valve with an analogue input command signal or connection of the valve to the CANBus control system of machine.

**Proportional valve with external electronic control unit EL7-E**

The valve can be controlled by external ECU EL7-E designed for connection to a DIN rail. The user electrically connects the ECU to the valve with a cable. The ECU EL7-E can be used for control of single solenoid or two solenoid valves.

Selection and setting of ECU parameters is described in **datasheet HA 9152**

**Valve with single solenoid and integrated ECU EL7-I\*-1**

The ECU in the form of connector plug is simply mounted on the socket of connector EN 175301-803-A of solenoid coil and fastened with a fixing screw.

**Valve with two solenoids and integrated ECU EL7-I\*-2-105**

The ECU in the form of connector plug is simply mounted on the socket of connector EN 175301-803-A of solenoid coil and fastened with a fixing screw. The second solenoid is connected to the ECU with a cable. If the integrated ECU EL7-I is ordered separately, the length of cable must be specified. The length of cable is defined as a distance between fastening screws of ECU and connector plug.

Selection and setting of ECU parameters is described in **datasheet HA 9151**

**Druh cívky elektromagnetu v milimetrech (in)**

E1, E2 Protection Degree IP65	E3, E4 Protection Degree IP67	E3A, E4A Protection Degree IP65	E8, E9	E12A, E13A Protection Degree IP67 / 69K
			<p>Note: A = Standard 300 mm (11.8 in), other lengths on demand</p>	

The indicated IP protection level is only achieved if the connector is properly mounted.

**Manual Override in millimeters (inches)**

No Designation - Standard (operated by pin)	Designation N2 - Rubber Boot Protected

In case of solenoid malfunction or power failure, the spool of the valve can be shifted by manual override as long as the pressure in port T does not exceed 25 bar (363 PSI). For alternative manual overrides contact our technical support.

**Dimensions in millimeters (inches)**

**PRM2-043.../-...E1**

**Valve with two solenoids**

Example with electrical terminal  
EN 175301-803-A (E1, E2)

Spool type  
3Z11, 3Z12, 3Y11, 3Y12

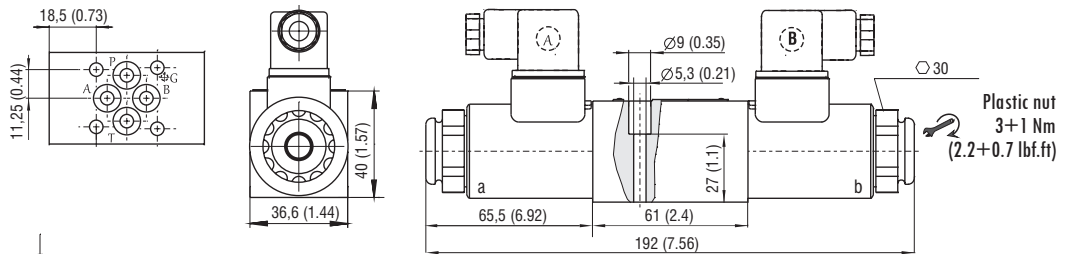

**PRM2-042.../-...E1**

**Valve with single solenoid "a"**

Spool type  
2Z51, 2Y51

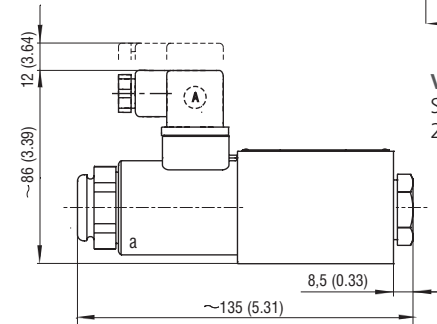

**Valve with single solenoid "b"**

Spool type  
2Z11, 2Y11

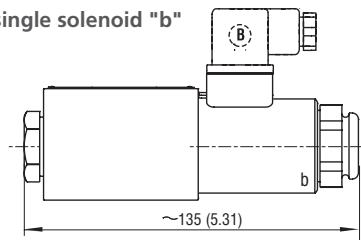

**PRM2-042\*/\*-EL7\*...**

**Valve with single solenoid "a" and integrated electronic control unit EL-I\*-1**

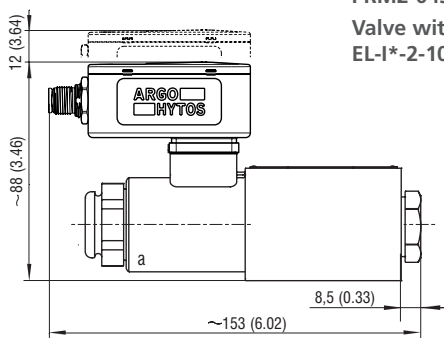

**PRM2-043\*/\*-EL7\*...**

**Valve with two solenoids and integrated electronic control unit EL-I\*-2-105**

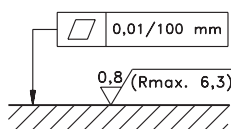
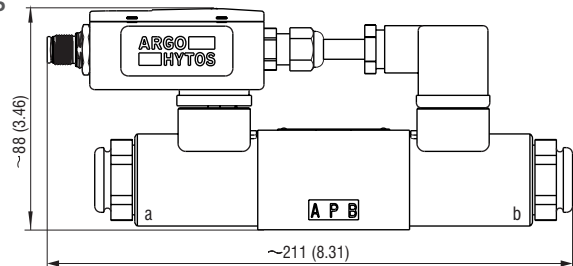

Required surface quality of the counterpart