

## 4/2 and 4/3 Directional Control Valve, Solenoid Operated

### RPE3-04

Size 04 (D02) •  $Q_{max}$  30 l/min (8 GPM) •  $p_{max}$  320 bar (4600 PSI)

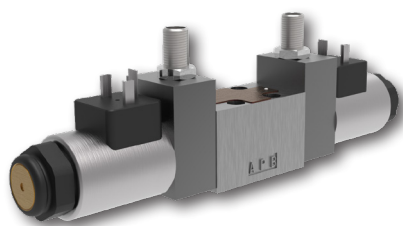

#### Technical Features

- › Direct acting, directional control valve with subplate mounting interface acc. to ISO 4401, DIN 24340 (CETOP 02)
- › High transmitted hydraulic power up to 320 bar with optimized design to minimize pressure drop
- › Three chamber housing design for production cost saving
- › The coil is fastened to the core tube with a retaining nut and can be rotated by 360° to suit the available space
- › The valve is available with interchangeable DC solenoids, also for AC power supply using a built-in rectifier bridge
- › Wide range of solenoid electrical terminal versions available
- › CSA Certificate upon request
- › Inductive contactless Normally Open and Normally Closed spool position sensor option
- › In the standard version, the valve housing is phosphated for basic surface corrosion protection and as preparation for painting. Steel parts are zinc-coated for 240 h salt spray protection acc. to ISO 9227
- › Enhanced surface protection for mobile sector available for the valve housing and steel parts (ISO 9227, 520 h salt spray)

ISO 4401-02-01-0-05

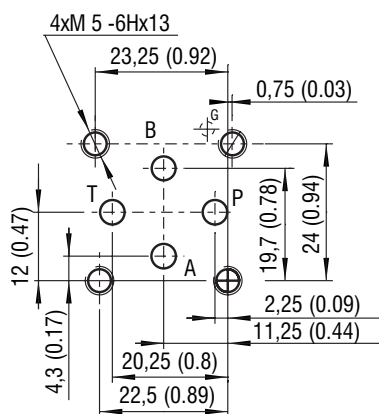

Ports P, A, B, T - max  $\varnothing$ 4.5 mm (0.18 in)

#### Technical Data

Valve size		04 (D02)	
Max. flow	l/min (GPM)	30 (8)	
Max. operating pressure at ports P, A, B	bar (PSI)	320 (4640)	
Max. operating pressure at port T	bar (PSI)	210 (3050)	
Fluid temperature range (NBR)	°C (°F)	-30 ... +80 (-22 ... +176)	
Fluid temperature range (FPM)	°C (°F)	-20 ... +80 (-4 ... +176)	
Ambient temperature range	°C (°F)	-30 ... +50 (-22 ... +122)	
Supply voltage tolerance	%	AC: $\pm$ 10	DC: $\pm$ 10
Max. switching frequency	1/h	15 000	
Switching time at $v=32$ mm <sup>2</sup> /s (156 SUS)	ON	ms	
	OFF	ms	
Weight	- valve with 1 solenoid	kg (lbs)	
	- valve with 2 solenoids	kg (lbs)	
		Datasheet	Type
General information		GI_0060	Products and operating conditions
Coil types / connectors		C_8007 / K_8008	C19B* / K*
Mounting interface / tolerances		SMT_0019	Size 04
Spare parts		SP_8010	
Subplates		DP_0002	DP*-04

#### Characteristics measured at $v = 32$ mm<sup>2</sup>/s (156 SUS)

#### Operating limits

Operating limits for maximum hydraulic power at rated temperature and supply voltage equal to 90% nominal.

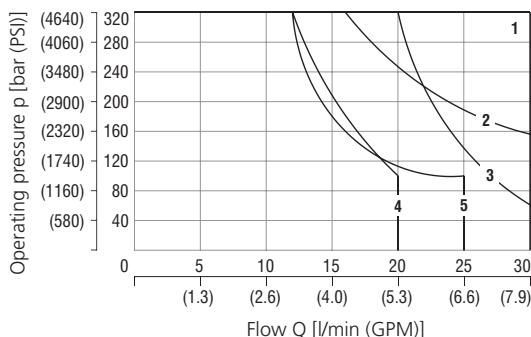

Spool symbol	Spool symbol
1	Z11, Z51, H11, P11, P51, Y11, Y51, B11, R11, X11, J15
2	C11, C51
3	R21
4	L21, A51, J75
5	Y71

#### Pressure drop related to flow rate

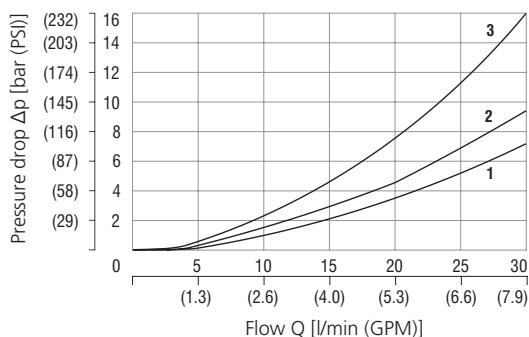

Spool symbol	P-A	P-B	A-T	B-T	P-T		P-A	P-B	A-T	B-T	P-T
Z11, P11, Y11, L21, B11	1	1	1	1		C11	3	3	3	3	2
R11, R21, X11, J15	2	2	2	2		C51	3			3	2
A51, J75	1	1				H11	1	1	1	1	2
P51, Y51, Z51		1	1			Y71	2		2	1	

For operating limits under conditions and flow directions other than shown contact our technical support.

### Ordering Code

RPE3 - 04   /      -

4/2 and 4/3 directional control valve, solenoid operated

Valve size

Number of valve positions

two positions **2**  
three positions **3**

Spool symbols

see the table "Spool Symbols"

Rated supply voltage of solenoids

(at the coil terminal)

12 V DC / 2.45 A		<b>01200</b>
24 V DC / 1.15 A		<b>02400</b>
27 V DC / 0.89 A		<b>02700</b>
205 V DC / 0.12 A		<b>20500</b>
24 V AC / 1.31 A / 50 (60) Hz		<b>02450</b>
120 V AC / 0.22 A / 50 (60) Hz		<b>12060</b>
230 V AC / 0.12 A / 50 (60) Hz		<b>23050</b>

CSA upon request

No designation  
**U**

**CSA Certified**  
without certification  
CSA marking

No designation

**A** zinc-coated (ZnCr-3), ISO 9227 (240 h)  
**B** zinc-coated (ZnNi), ISO 9227 (520 h)

**Surface treatment**  
standard

No designation  
**S1**  
**S4**

**Spool monitoring**  
without sensors  
normally-open sensor  
normally-closed sensor

No designation  
**V**

**Seals**  
NBR  
FPM (Viton)

No designation

**N2**  
**N4**  
**N5**

**Manual override**  
standard (operated by pin)  
rubber boot protected  
hand screw  
socket head screw

**Connector**

**E1**

**E2**

**E3**

**E4**

**E3A**

**E4A**

**E5**

**E8**

**E9**

**E12A**

**E13A**

EN 175301-803-A  
E1 with quenching diode  
AMP Junior Timer - radial direction  
E3 with quenching diode  
AMP Junior Timer - axial direction (2 pins; male)  
E3A with quenching diode  
EN 175301-803-A with integrated rectifier  
Loose conductors (two insulated wires)  
E8 with quenching diode  
Deutsch DT04-2P - axial direction (2 pins; male)  
E12A with quenching diode

- For directional valves with two solenoids, one solenoid must be de-energized before the other solenoid can be charged.
- For AC voltage supply use coils with connector type E5.
- For other solenoid voltage supply options see datasheet C\_8007.
- The solenoid operated valves are delivered without connectors. For available connectors see datasheet K\_8008.
- The orifice to the P port can be ordered separately, see datasheet SP\_8010.
- Mounting bolts M5 x 35 DIN 912-10.9 or studs must be ordered separately. Tightening torque is 5+1 Nm (3.7+0.7 lbf.ft).
- Besides the commonly used valve versions shown other special models are available. Contact our technical support for their identification, feasibility and operating limits.

### Spool Symbols

Type	Symbol	Interposition	Type	Symbol	Interposition	Type	Symbol	Interposition
Z11			Y71			Z51		
C11			R11			Z11		
H11			R21			X11		
P11			A51			C11		
Y11			P51			H11		
L21			Y51			J15		
B11			C51			J75		

### Solenoid Coil in millimeters (inches)

E1, E2 Protection degree IP65	E3, E4 Protection degree IP67	E3A, E4A Protection degree IP67	E5 Protection degree IP65
E8, E9	E12A, E13A Protection degree IP67 / IP69K		

The indicated IP protection level is only achieved if the connector is properly mounted.

### Manual Override in millimeters (inches)

No designation - standard (operated by pin)	Designation N2 - rubber boot protected	Designation N4 - hand screw	Designation N5 - socket head screw, size 3

In case of solenoid malfunction or power failure, the spool of the valve can be shifted by manual override as long as the pressure in port T does not exceed 25 bar (363 PSI). For alternative manual overrides contact our technical support.

### Spool Position Sensor

**S1** - Circuit diagram for the normally - **OPEN** sensor

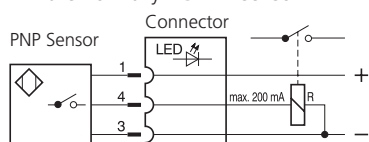

**S4** - Circuit diagram for the normally - **CLOSED** sensor

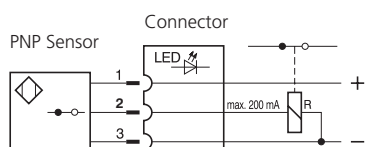

#### Function of the position sensor:

In the basic position (when the solenoid is switched off), a steel core, connected to the spool, is under the position sensor. The sensor is activated, it means contacts of the sensor S1 are closed and contacts of the sensor S4 are open. After switching on the solenoid the spool with core moves out of the sensor range and the sensor is deactivated.

Technical Data of the Sensor		S1, S4
Rated power supply voltage	V	24 DC
Power supply voltage range	V	10 ... 30 DC
Rated current	mA	200
Sensor enclosure protection (EN 60529)		IP 67
Max. operating pressure	bar (PSI)	210 (3046)
Switching frequency	Hz	1000
Ambient temperature range	°C (°F)	-25 ... +80 (-13 ... +176)
Technical Data of the Connector		
Power supply voltage range	V	10 ... 30 DC
Ambient temperature range	°C (°F)	-25 ... +80 (-13 ... +176)
Indicator		yellow LED

#### Typical configurations of the valve with a sensor:

3-position valve with two solenoids, equipped with two sensors

2-position valve with one solenoid, equipped with one sensor on the solenoid side

2-position valve with a detent assembly of spool, equipped with one sensor on the side of the solenoid which moves the spool from the basic position to the switched position according to the spool symbol

**Note:** the sensor always indicates the change of spool position realised by the energised solenoid, mounted on the side of sensor.

Signal of solenoid ①	Signal of sensor ③	Two-Position Directional Control Valve					
		① a(b)		③ Sa(Sb)		LED	
		S1	S4	S1	S4		
0	1	0	0	ON	OFF		
1	0	1	1	OFF	ON		

① a(b)	③ Sa(Sb)	Three-Position Directional Control Valve							
		S1		S4		LED			
a	b	Sa	Sb	Sa	Sb	Sa - LED	Sb - LED	Sa - LED	Sb - LED
0	0	1	1	0	0	ON	ON	OFF	OFF
1	0	0	1	1	0	OFF	ON	ON	OFF
0	1	1	0	0	1	ON	OFF	OFF	ON

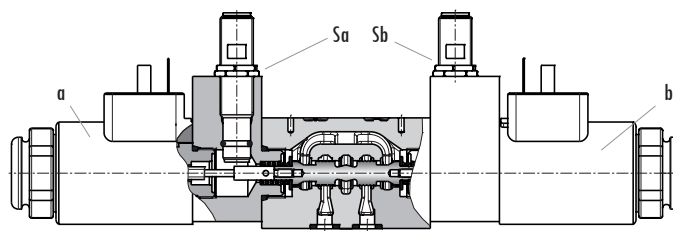
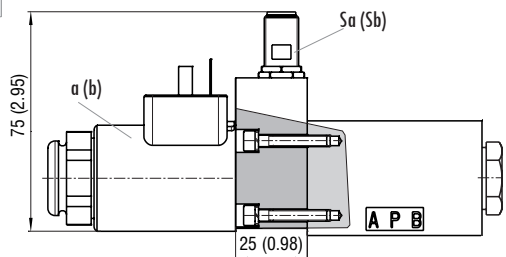

## Dimensions in millimeters (inches)

### RPE3-043\*/\*E1\*

Valve with two solenoids  
Spool symbols Z11, C11, H11,  
P11, Y11, L21, B11, Y71

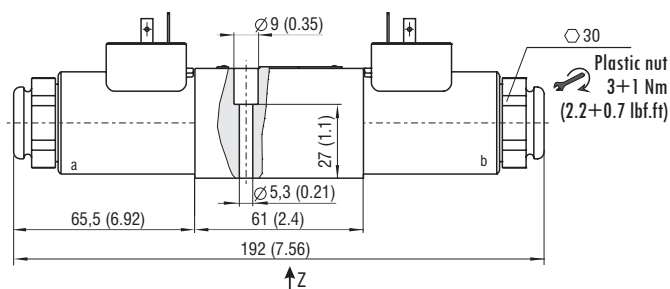
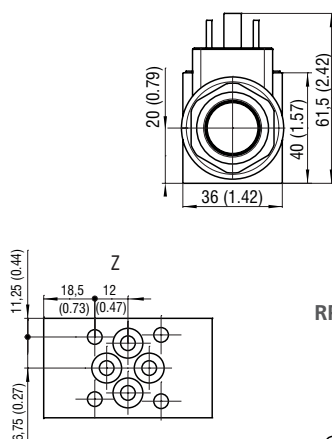

### RPE3-043\*/\*E1\*S\*

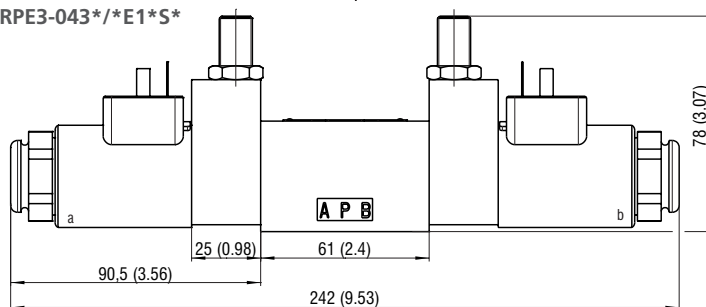

### RPE3-042\*/\*E1\*

Valve with one solenoid „a“  
Spool symbols R11, R21,  
A51, P51, Y51, C51, Z51

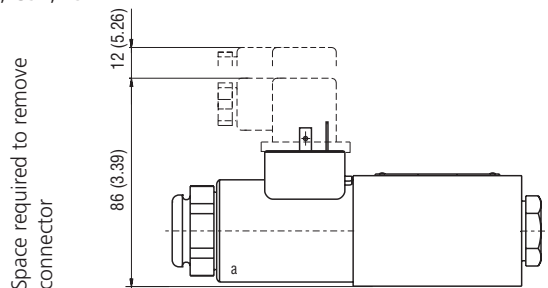

### RPE3-042\*/\*E1\*

Valve with one solenoid „b“  
Spool symbols Z11, X11, C11, H11

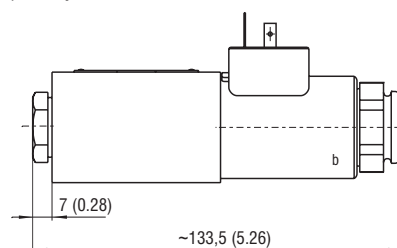

### RPE3-042\*/\*E1\*S\*

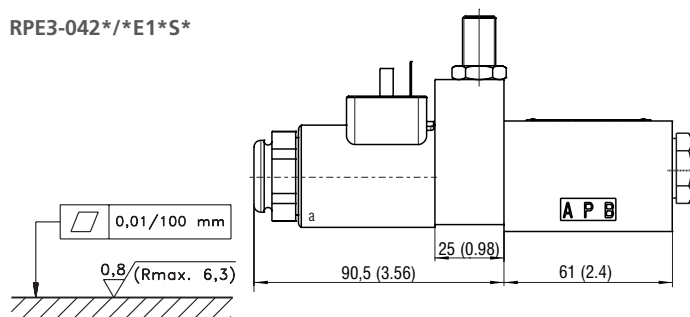

### RPE3-042\*/\*E1\*S\*

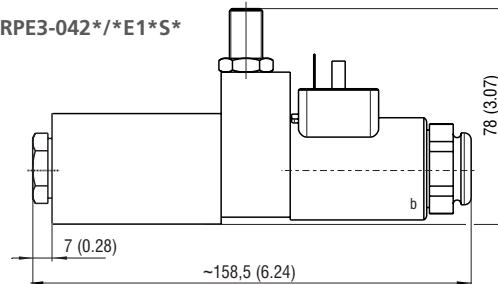

Required surface quality of  
the counterpart