

FULL RANGE PRESSURE COMPENSATING VARIABLE FLOW CONTROL

“FC”

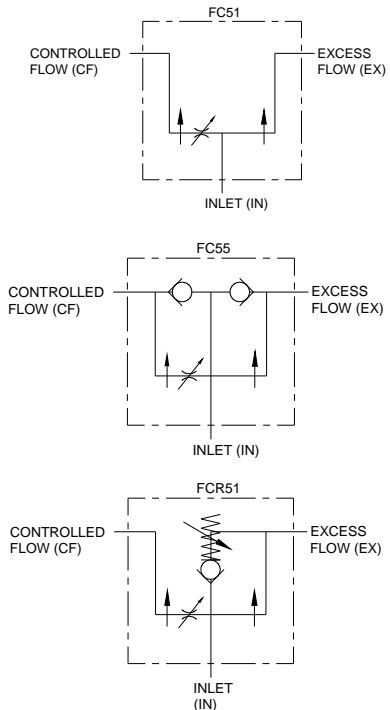

FC51-3/4

FCB51-3/4

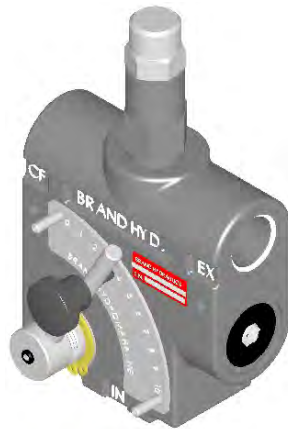

FCR51-3/4



FEATURES:

- **DIAMOND HONED SPOOL BORE** provides consistent spool fit with low leakage.
- **EVERY FC IS TESTED** for shutoff, max. flow, and pressure compensation.
- **STANDARD 3-PORT** allows for pressure compensated flow out of two ports.
- **STANDARD 416 STAINLESS STEEL** rotary lever spool to prevent the spool from locking up.
- **STANDARD SAE ORB COMPENSATOR PLUGS** to eliminate external leakage from the compensator bore.
- **EXTERNAL SEALS ON ROTARY SPOOL** prevents contamination from locking up spool.
- **OPTIONAL TOP PORT** allows the customer to plumb their pipe directly in line with the inlet.
- **OPTIONAL 2-PORT** allows for pressure compensated flow out of one port.
- **OPTIONAL 316 STAINLESS STEEL** rotary spool provides highest corrosion resistance.
- **OPTIONAL FREE REVERSE FLOW** allows fluid to move from the CF (control flow) and EX (excess flow) port to the inlet. (Single reverse flow is also available)
- **OPTIONAL ADJUSTABLE BALL SPRING RELIEF AND HIGH LIFT BALL SPRING RELIEF** CF (control flow) port.

SPECIFICATIONS:

- See flow chart for capacity.
- Rated for 3000 psi (207 bar).
- Weighs 7- 3/4 lbs. (3.52 kg).
- 30-Micron Filtration Recommended.

MATERIALS:

- Cast Iron Body.
- Heat Treated Compensator Spool.
- Stainless Steel Rotary Spool.
- Buna N O'Rings (Standard)
- Heat Treated Free Reverse Check Seat.

Flow Control Valves

FC – GENERAL INFORMATION

Full range pressure compensating variable flow control is designed so that the orifice area varies as the lever is rotated. Fluid travels past the variable orifice, through the compensator spool and then out the controlled flow port. Therefore the flow out of the CF port is proportional to the orifice area which can vary from closed to open. The sum of the controlled flow and the excess flow equals the inlet flow and as the controlled flow increases the excess flow decreases. Both outlet flows are pressure compensated with a spool that maintains a constant flow by adjusting for pressure. Hunting between the compensated pump and our valve is dampened with a dashpot on the compensator spool. Thus, the outlet flow is smooth and constant regardless of the pressure on the CF and EX port. External seals on the rotary spool prevent contamination from getting between the spool and the casting, thus preventing the spool from locking in one position. All FC's are built with stainless steel (416) rotary spools to help prevent the rotary spools from locking up when they are in a corrosive environment. We also offer the FC with outlet ports coming from the top of the casting.

ADJUSTABLE BALL SPRING RELIEFS – The adjustable ball spring relief (R) and the adjustable high lift ball spring relief (B) allow the customer pressure compensated flow up to the pressure setting on the relief. Once the pressure on the CF port increases above the relief setting the relief valve opens and diverts flow to the EX port while maintaining the pressure on the CF port. The EX port must be plumbed back to tank for both of these reliefs. Both relief options are preset to 1500 psi (103 bar), standard, and field adjustable from 750 to 3000 psi. (52 to 207 bar). Pressure settings between 250 and 750 psi (17 and 52 bar) can be achieved by using a different spring. The B option's advantage over the R option is that the cracking pressure at low and high flow is virtually the same. The B option is also more stable when flow is traveling past the ball and spring. (See relief flow charts on next page)

FREE REVERSE FLOW – The free reverse flow (55) option is designed primarily where cylinders and motors are needed to go in reverse. Flow can go in reverse from either the EX or the CF port to the inlet. Flow is not metered when it goes in reverse. The non-metered flow travels past the poppet, down the center of the valve, past the compensator spool and through the inlet. The steel poppet seat inside the free reverse flow check is heat treated to assure a long life.

FC – EXAMPLES OF COMMON MODEL CODES:

- FC51-3/4**..... 3/4" ports and a max flow of 30 gpm (114 lpm).
- FCR51-3/8**..... Ball spring relief (1500 psi (103 bar) setting), adjustable from 750 to 3000 psi (52 to 207 bar), 3/8" ports, and a max flow of 8 gpm (30 lpm).
- FC55-1/2**..... Free reverse flow, 1/2" ports, and a max flow of 16 gpm (61 lpm).

FC – CREATING A MODEL CODE FOR FC'S:

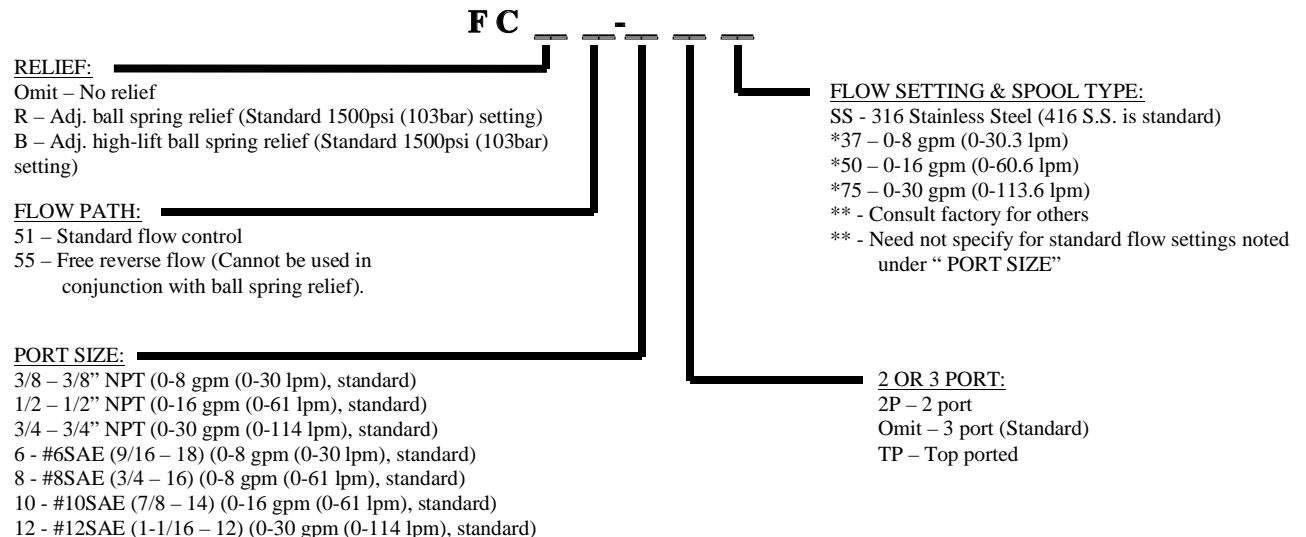

FC FLOW & PRESSURE INFO:

Controlled Flow vs. Dial Plate for FC Series

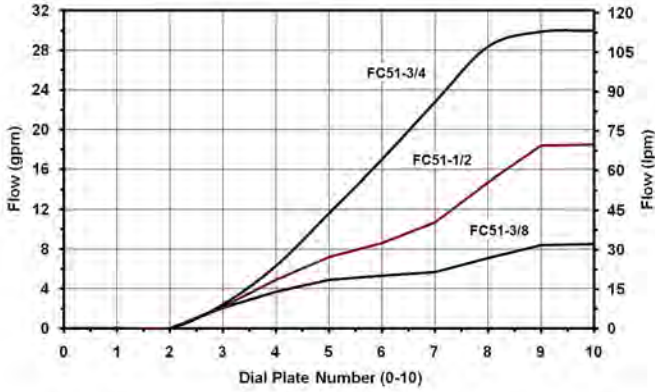

Pressure Drop vs. Flow for FC Series

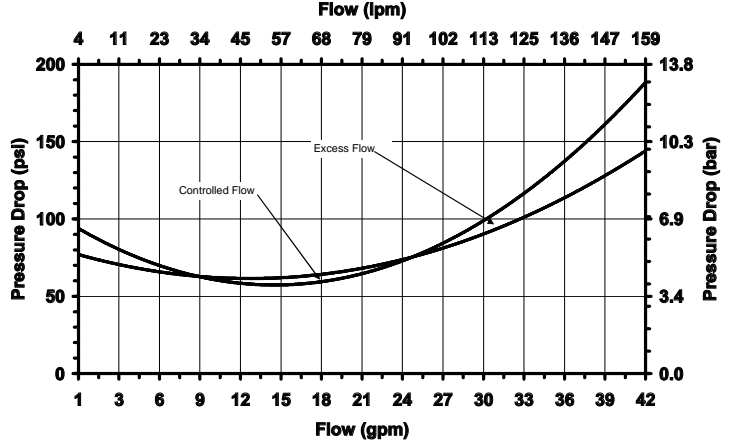

Pressure vs. Flow for FCR51

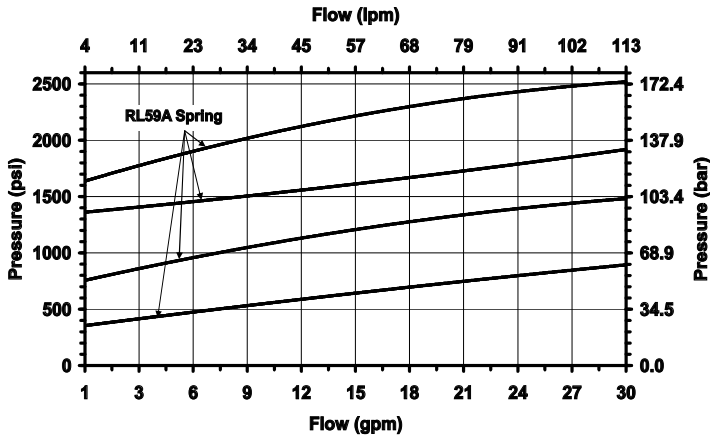

Pressure vs. Flow for FCB51

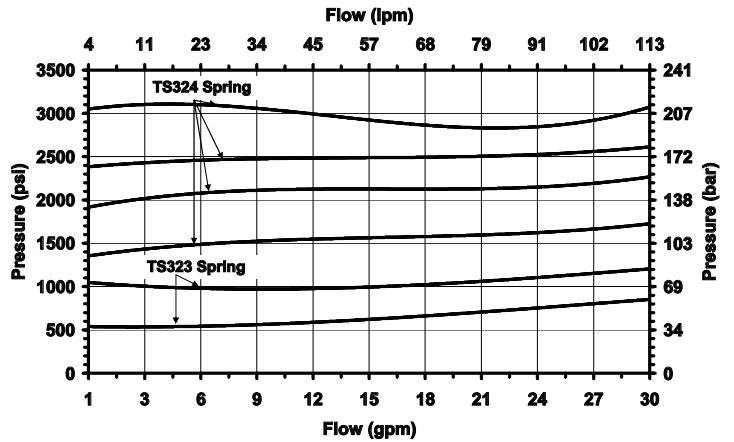

DIMENSIONAL DATA:

**FCB51 AND FC51 DIMENSIONAL DATA (inches & [millimeters]):
(FCB51 SHOWN):**

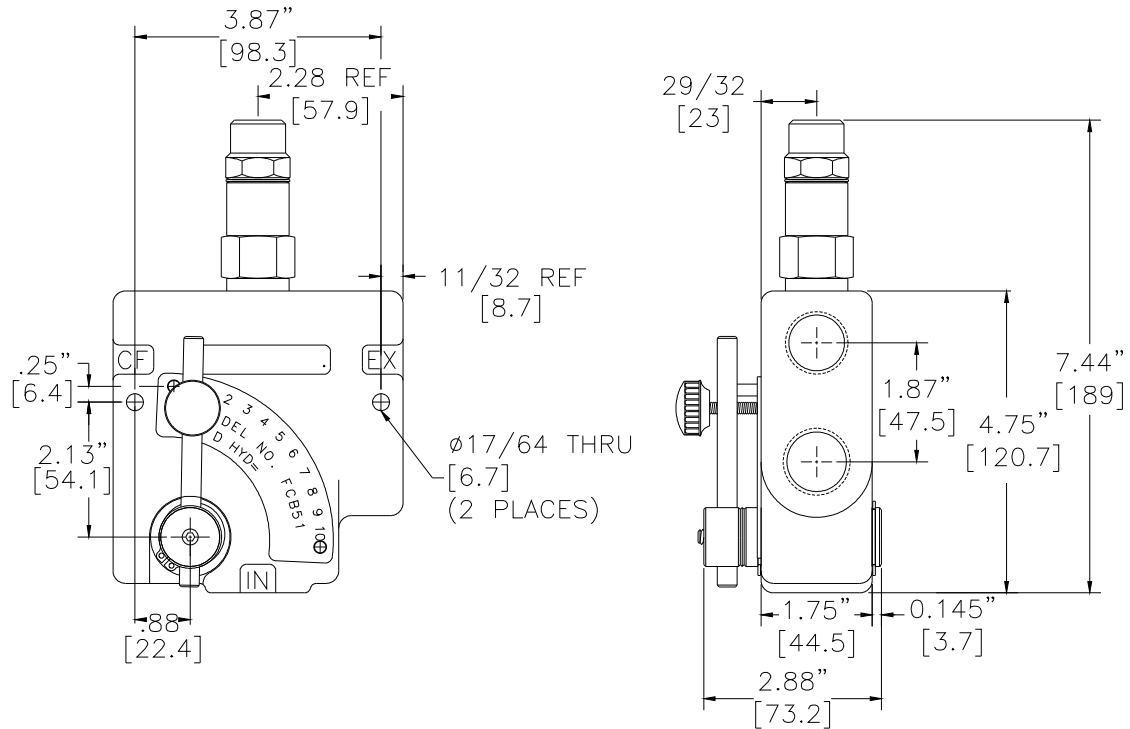

**FCR51 AND FC51 DIMENSIONAL DATA (inches & [millimeters]):
(FCR51 SHOWN):**

