

## Single axis finger joystick with power outputs (PWM)

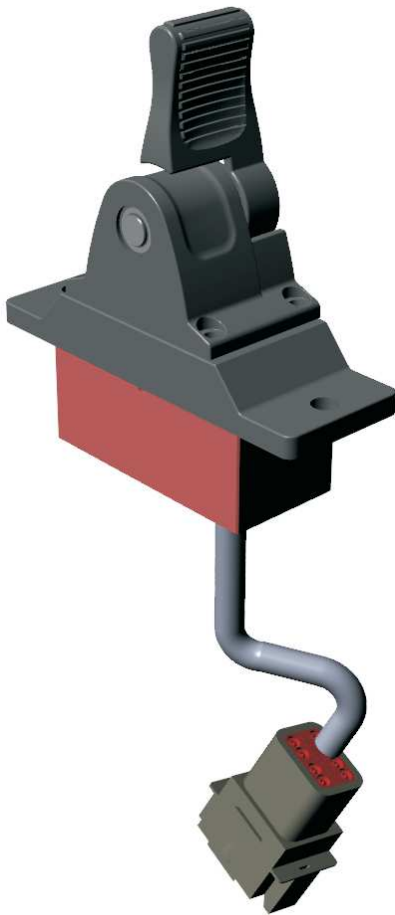

### Description

MAP2L is a single axis electronic joystick with PWM outputs, able to directly drive a couple of PWM solenoid valves.

Joystick command is based on the measurement of magnetic field of a permanent magnet through redundant Hall effect probes, not subject to wear and tear.

#### Main features:

- one proportional section (A+B) direct control (2 PWM outputs max 2.5A);
- adjustable minimum/maximum current for each directions (A+B);
- adjustable rise/fall timeramp up to 25 seconds (step 0.1s);
- adjustable PWM frequency from 50 to 300 Hz;
- input for speed reduction or deadman feature or "fault" output (default);
- paddle with friction version available (retained paddle);
- output curve shape: linear or parabolic (selectable);
- DV digital output is activate when PWM output is on;

All working parameters are adjustable through a serial port and the Windows® SepSim program using a special serial port adapter (AISR).

The version with voltage signal output is also available (MAS2L).

### Connections

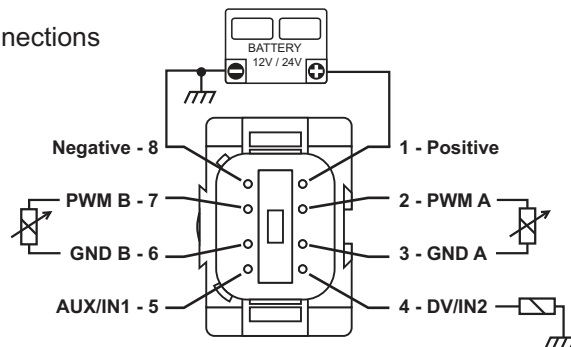

### Technical specifications

Power Supply Voltage	10 ÷ 30 Vdc
Supply current	90 mA + load
Working Temperature Range	-30 ÷ +70 °C
PWM Output Minimum Current	50 ÷ 2500 mA (250 mA preset)
PWM Output Maximum Current	50 ÷ 2500 mA (850 mA preset)
PWM Frequencies	50 ÷ 300 Hz (100 Hz preset)
DV and AUX output maximum current	2000 mA
Connections	Cable L=20 cm with Deutsch DT04-8 connector
Working Angle	± 30 degrees
Force for paddle at full stroke	Approx. 3.5N ±10% (measured on the top of paddle)
Ingress Protection Rating	IP66
EMC compatibility	ISO EN 14982:2009

**Working mode**

MAP2L joystick is designed to directly control two proportional solenoid valves (one section of an electrically controlled hydraulic distributor). The PWM command of the coils is feedback controlled, in order to guarantee the current stability independently to external factors (power supply voltage, coil temperature, ...).

The frequency of the PWM outputs is adjustable from 50 Hz to 300 Hz (preset to 100 Hz).

The electronic card is protected against short-circuits of the load.

The MAP2L joystick is preset for a generic 24 V proportional valve, with 250 mA minimum current and 850 mA maximum current. Fall and rise timeramps are preset to zero.

It can be necessary to modify the original preset values, in order to achieve better performances of the joystick in various applications (with different supply voltages or with different kind of proportional solenoid valves).

Setting can be changed using a PC with the SepSim Windows® program and a special serial port adapter with M8 connector (code: PISPR).

**Signaling**

A multicolor LED under the mounting panel is lit when joystick is supplied and gives information on the status of the device with a coded series of colored flashes.

**DIMENSIONS** (in millimeters)

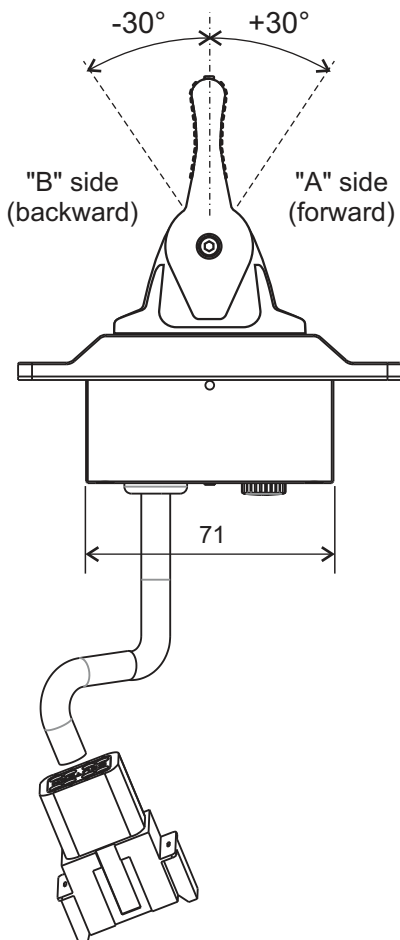

Example of ordering codes:

**PMAP2SSL\_nnn** ← nnn (optional): customized special version

- R: paddle spring return
- F: paddle with friction

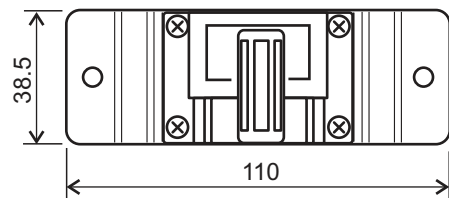
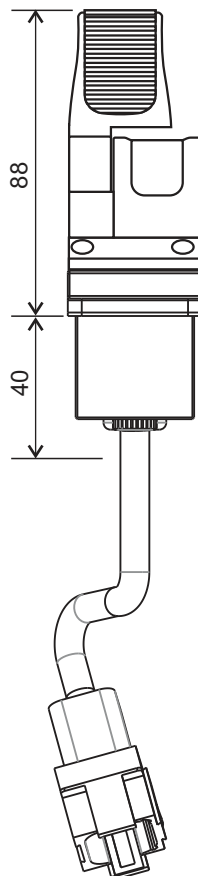

Top View

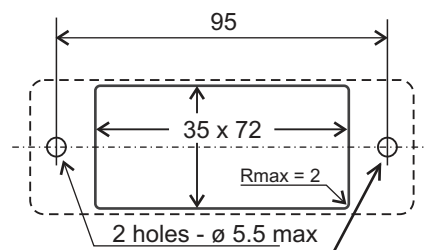

Drill mask

Mounting screws must be sealed apart (rubber gasket does not seal them)

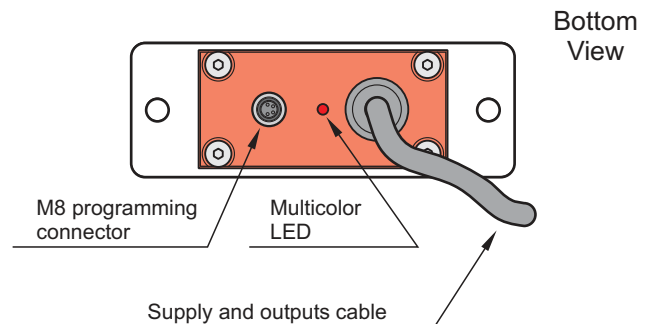

Bottom View