

DESCRIPTION

STU-PWM electronic card is a regulator for proportional solenoid valves, which can drive up to 8 modules (8+8 PWM outputs), starting from analog inputs (input signal range from 0 to 5V). If the inputs analog signals are generated from potentiometric joysticks, the control card provides a stabilized 5V supply to power them.

INPUTS

- n° 8 analog inputs signals (range from 0 to 5V);
- n° 1 enable input defined as CONTROL PANEL ON;
- n° 2 ENABLE inputs with different operating features;
- n° 1 input to select FAST/SLOW mode (optional);
- n° 3 ON/OFF inputs, directly carried to three power outputs;

OUTPUTS

- n° 8+8 PWM outputs, to drive proportional solenoid valves (a pair of outputs for each analog inputs);
- n° 1 DUMP VALVE output driven by all manoeuvres;
- n° 1 FAULT output;
- n. 3 ON/OFF outputs, directly driven by three ON/OFF inputs (max 2.5A);

FEATURES

Adjustable PWM frequency, min/max output currents and rise/fall time ramps. As option, STU-PWM is available with two selectable speeds (FAST/SLOW mode), to operate a different maximum speed in different operating conditions; it is possible to enter in FAST mode only when all the joysticks are in rest position.

It is also available a DUMP VALVE output that is turned on when a manoeuvre turns on. This output has a programmable delay on switch off, to avoid elevated pressure spikes in the hydraulic circuit.

The control unit provides three ON/OFF input/output to drive directly solenoid valves, starting from low power command signal.

- To ensure more safety during working mode, the electronic card provides:
- programmable deadband, electrical stroke and adjustable signal threshold;
 - an overall relay, feedback controlled, supply all control unit's outputs;
 - three inputs ENABLE signals (CONTROL PANEL ON, ENABLE1 and ENABLE2);
 - an output to control the DUMP VALVE;
 - an output (FAULT) to drive a warning light or a relay that report errors on analog inputs.

WORKING SPECIFICATIONS

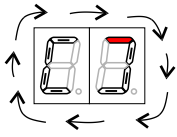

When you turn on the device, the control unit stays in idle mode, waiting for the CONTROL PANEL ON signal. In this working mode the display shows a led that rotates clockwise direction, the relay on the control unit is not excited and all outputs are turned off.

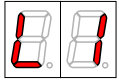

When you provide the CONTROL PANEL ON signal, the control unit checks all analog inputs signals. The signals must be inside the CALIBRATION BAND, which is +/- 45% of setted DEADBAND. The analog signal acquired in turning on mode will be taken as zero position value for the working mode, to compensate a little calibration errors of joysticks and to use all their electrical stroke.

At end of calibration, during the working mode, two-digit display shows following informations.

The leds of the left digit shows the inputs state, led is on when a positive voltage is connected to the input. The leds of the right digit are on when the matching analog input is not at zero position.

Display shows input state, regardless the output state, for instance because one of the enable signal is not provided.

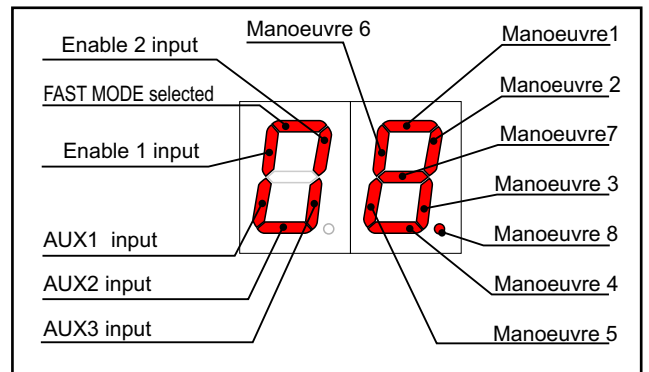

ENABLE SIGNALS

PWM outputs can be turned on only if ENABLE1 and ENABLE2 signals are provided at the same time. ENABLE1 signal can be connected to the safety microswitches under the joysticks, at the signal switch off all the operating manoeuvres are turned off following the falling timeramp, if they are setted. At the ENABLE2 signal switch off all the operating manoeuvres are turned off, ignoring the falling timeramp.

OUTPUTS LOCK

Analog inputs are monitored continuously; if one of inputs is not at zero position on the control unit turn on, or if one of inputs overcomes min/max threshold during the working mode, the display shows an error message, indicating which input have caused the error.

At the same time the manoeuvre that caused the error is forced in locked state, until the operator reset the control unit. The others manoeuvres continue to work normally. To reset the control unit, the CONTROL PANEL ON signal has to be turned off and then turned on again. In this step all joysticks have to be at zero position. FAULT output is turned on when an error occurs.

Error signalling is shown when the inputs are at zero position; when a manoeuvre is turned on, the display shows standard working informations, as described in the picture before. The error signalling will be shown again when the manoeuvre is turned off.

DUMP VALVE OUTPUT

Every time a PWM output is turned on, also the DUMP VALVE output turns on. The turning off DUMP VALVE delay is default programmed to one second. This delay can be modified in a range from 0 to 2.5 seconds.

DISPLAY SIGNALLING

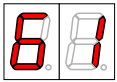

FIRMWARE PRESENTATION

At start up, the electronic card shows the number of enabled PWM outputs (4, 5, 6, 7 or 8, on the left) and the number of enabled speed sets (1 or 2, on the right).

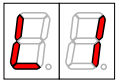

LOAD INPUTS

This message is shown at CONTROL PANEL ON signal power on, during the inputs control. Do not push/pull any joysticks during this message.

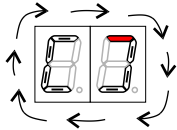

WAITING FOR CONTROL PANEL ON SIGNAL

Only one led is turned on showing a clockwise movement. STU/PWM is waiting for CONTROL PANEL ON signal, all outputs are switched off.



CLOSED RELAY CONTACT ERROR

The relay contact is find closed before the command signal is given. To reset: switch off and turn on the control unit. If error persist, the control unit has to be replaced.



OPEN RELAY CONTACT ERROR

The relay contact can not close: probably relay's coil is damaged. To reset: switch off and turn on the control unit. If error persist, the control unit has to be replaced.

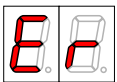

PROPORTIONAL SIGNAL ERROR

This visualization is followed by a set of one or more leds blinking, they indicate which inputs caused the error. The match between inputs and blinking leds is the same shown in the previous page.

Error can be occurs:

- at power on: if one of inputs is not at zero position when CONTROL PANEL ON signal is provided;
- during the working time: if one of inputs overcomes the min/max working threshold;

To reset: switch off and turn on the control unit. If the problem persists, disconnect the wire associated to the damaged input and reset the control unit.

Example: analog 2 input out of working range

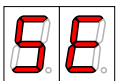
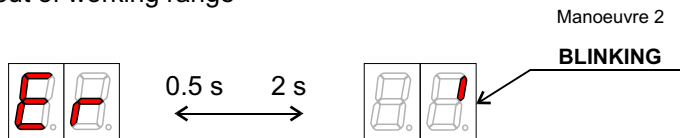

SAVE EEPROM

This message is shown when you are saving in EEPROM parameters values.

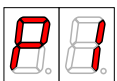

KEYBOARD PROGRAMMING

This message is shown when you are in programming mode. The right digit can go from 1 to 9, and then "A", "b", "C", "d", "E", "F", for programming steps from 10 to 15 (not all steps are present).

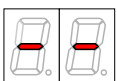

This message is shown when you are in programming mode, for steps from P1 to P5. The control unit is waiting that the operator pushes or pulls a lever to choose which manoeuvre he wants calibrate.

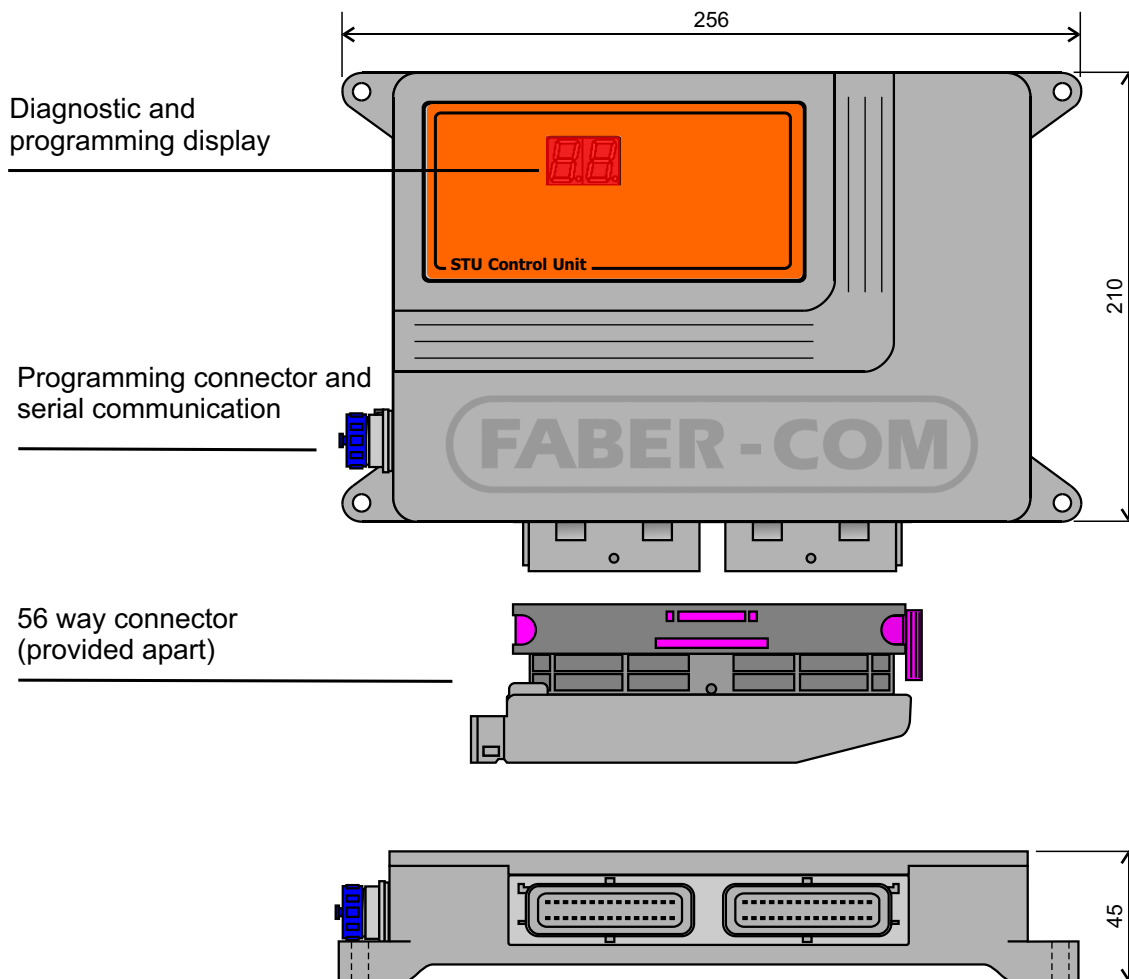

Ordering codes for STU-PWM control unit (connector not included):

Code: PSCH52__

- R - with two speed set
- 4 - 4 functions (4+4 PWM output)
- 5 - 5 functions (5+5 PWM output)
- 6 - 6 functions (6+6 PWM output)
- 7 - 7 functions (7+7 PWM output)
- 8 - 8 functions (8+8 PWM output)

56 way female connector ordering code: **PCVF56** (protection cover, crimping terminals and taps included)

TECHNICAL SPECIFICATIONS

Power supply voltage	10Vdc ÷ 30Vdc (inner 5x20 8A fuse type F8A)
Current absorption	300 mA + load outputs (max 7.5A)
Supply for external potentiometers	+5V - max current 50 mA
Working temperature range	-20 ÷ +70 °C
PWM minimum current range	from 100 to 2500 mA
PWM maximum current range	from 100 to 2500 mA
PWM frequency	50-60-70-85-100-125-150-200-250-300 Hz
ON/OFF outputs maximum current	2500 mA (700 mA for FAULT output)
Analog inputs impedance	11 KOhm towards 2.5V
Overall dimensions with connector mounted	256 x 210 x 45 mm
Drill interaxis	242 x 142 mm (n. 4 holes of 6 mm diameter)

CONNECTIONS

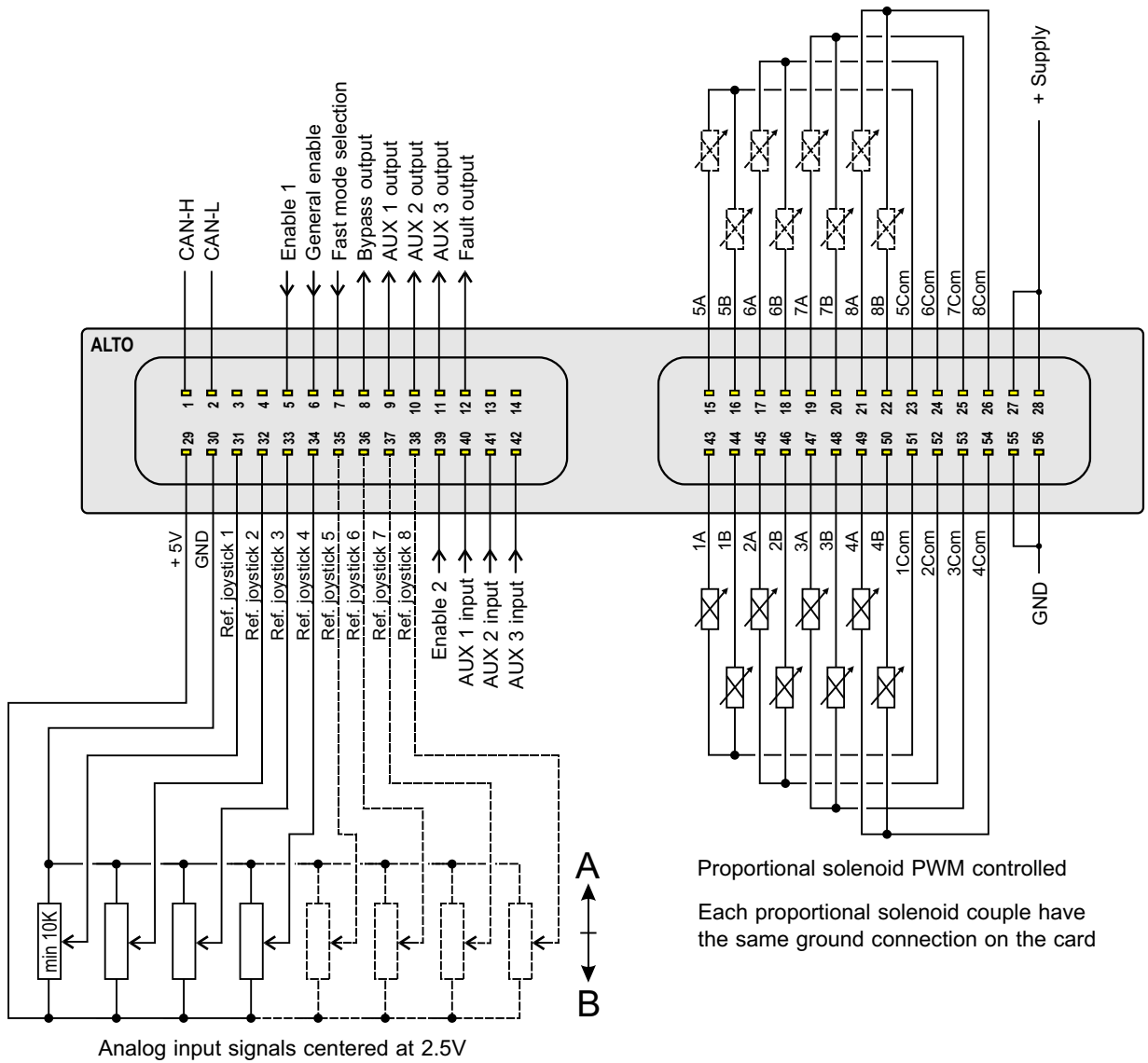

Joysticks can be supplied by an external stabilized supply, but the negative must be common with the STU card.

Reference signals from joysticks must not exceed +5V.

ATTENTION

Protection against reverse supply voltage is passive (inverse polarized diode in parallel to the supply). Inverting supply voltage inner 5x20 8A fuse blows. To replace the fuse take away the cover unscrewing the four screws on the backside. Replace it with a same type fuse (FAST 8A).

PROGRAMMABLE PARAMETERS

The following parameters are adjustable for each manoeuvre and for each single side of movement:

- P1 - **Minimum current:** output current when the signal overcomes deadband. It is the same for HIGH and LOW speed.
- P2 - **Fast mode maximum current:** output current when the signal's stroke ends.
- P3 - **Slow mode maximum current:** output current when the signal's stroke ends in slow mode (optional).
- P4 - **Rise timeramp:** time taken by current to go from its minimum to maximum value.
- P5 - **Fall timeramp:** time taken by current to go from its maximum to minimum value.

The following parameters are used by all manoeuvres:

- P6 - **BYPASS turning off delay.**
- P7 - **Deadband** of analog input.
- P8 - **Electrical stroke** of analog input.
- P9 - **Min/Max threshold** of analog input.
- PA - **PWM frequency.**

NOTE: Slow mode set is only available in -R version of the device. If Slow mode set is not enabled, P3 programming step will be present but it will have no effect on the outputs.

PROGRAMMING DEVICES

There are two ways to adjust parameters values, by a special programming keyboard (PRG2) or by a software with a PC serial port. PC software needs Windows operative system and a serial interface adaptor. Through serial communication software the operator can adjust all parameters values, regardless the manoeuvres connection. He can also save the calibration parameters in a file, and then download it on another control unit.

NOTE: To be able to use the programming keyboard, you are required to independently push/pull each manoeuvre that has to be calibrated, because this is the only way to select the parameter associated with a manoeuvre.

PROGRAMMING KEYBOARD DESCRIPTION

Before to start the programming operations the operator must:

- turn on the control unit and give the CONTROL PANEL ON, ENABLE1 and ENABLE2 signals.
- connect the keyboard to the programming connector;

The device works normally except for the display which will show programming informations. During the programming mode, the display alternatively shows the programming step (for 1 second) and the current parameter's value (for 5 seconds). During the calibration of a parameter, only the value of the parameter itself is shown. The programming steps from P1 to P5 require the selection of a manoeuvre, by the push/pull of the related lever. If no manoeuvre is selected, the display shows:

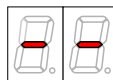





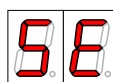

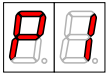
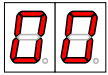

When PRG2 is connected, the speed set will NOT be selected by the *Fast mode selection input* but STUi remains always in *Fast mode* except when you are in step P3.

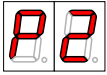
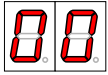
You can move through steps pushing the PREV/NEXT buttons on the keyboard. To modify the parameter's value, use the +/- buttons: these buttons are equipped with autorepeat. At the end of the calibration procedure, push synchronously PREV and NEXT buttons. The display will show for a few seconds the following message:

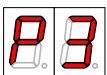
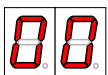
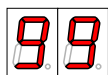
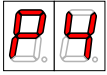
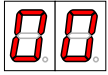
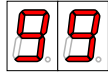
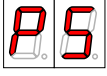
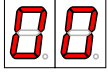
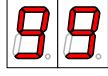
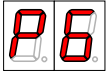
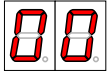
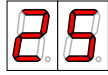
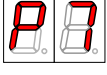
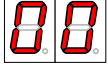

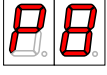
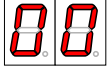
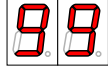
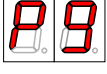
When the message turns off, you can disconnect the keyboard.
The next time you turn on the control unit, the new parameter values will be loaded.

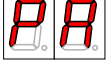
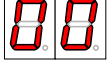
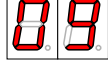
STEP	MIN / MAX VALUES	DESCRIPTION
1 s	5 s	
	\leftrightarrow  \div 	Minimum Current , each unit indicates 25 mA (eg.: display value = 16 - current = 400 mA) Output current when the signal overcomes deadband.
	\leftrightarrow  \div 	Maximum Current (FAST MODE set) , each unit indicates 25 mA (eg.: display value = 60 - current = 1500 mA) Output current when the signal's stroke ends.
	\leftrightarrow  \div 	Maximum Current (SLOW MODE set) , each unit indicates 25 mA (eg.: display value = 40 - current = 1000 mA) Output current when the signal's stroke ends.
	\leftrightarrow  \div 	Rise Timeramp : each unit indicates 0.1 seconds (eg.: display value 10 - delay = 1.0 sec.) Time taken by current to go from minimum to maximum value.
	\leftrightarrow  \div 	Fall Timeramp : each unit indicates 0.1 seconds (eg.: display value 10 - delay = 1.0 sec.) Time taken by current to go from maximum to minimum value.
	\leftrightarrow  \div 	Bypass Turning Off Delay , each unit indicates 0.1 seconds (eg.: display value 10 - delay = 1.0 sec.) Bypass output stays on for this time when the manoeuvres stop.
	\leftrightarrow  \div 	Deadband of analog input, each unit indicates 25 mV (eg.: display value 15 - threshold = 0.375 Volt). All the manoeuvres use this deadband value.
	\leftrightarrow  \div 	Electrical Stroke of analog input, each unit indicates 25 mV (eg.: display value 60 - stroke = 1,5 Volt) All the manoeuvres use this electrical stroke value.
	\leftrightarrow  \div 	Max Threshold of analog input, each unit indicates 25 mV (eg.: display value 4 - threshold = 0,1 Volt). Tolerated range from 0,1V to 4,9V. FAULT output on if signal overcomes these limits.
	\leftrightarrow  \div 	PWM Frequency : 0 = 50 Hz; 1 = 60 Hz; 2 = 70 Hz; 3 = 85 Hz; 4 = 100 Hz; 5 = 125 Hz; 6 = 150 Hz; 7 = 200 Hz; 8 = 250 Hz; 9 = 300 Hz.

PRESETTED CALIBRATION

Recommend for FABER-COM MANP bidirectional potentiometric joystick.

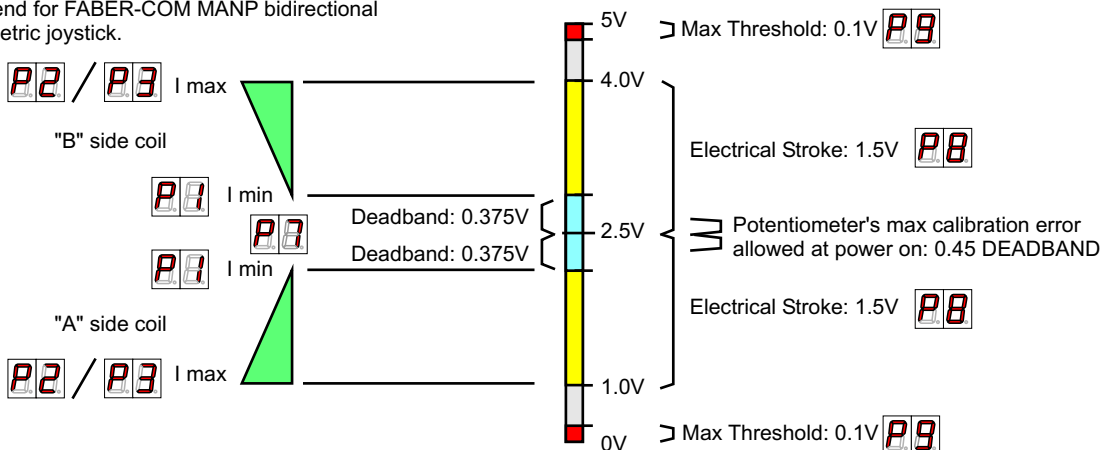

EXAMPLE OF CONNECTION TO PERSONAL COMPUTER BY SERIAL ADAPTER

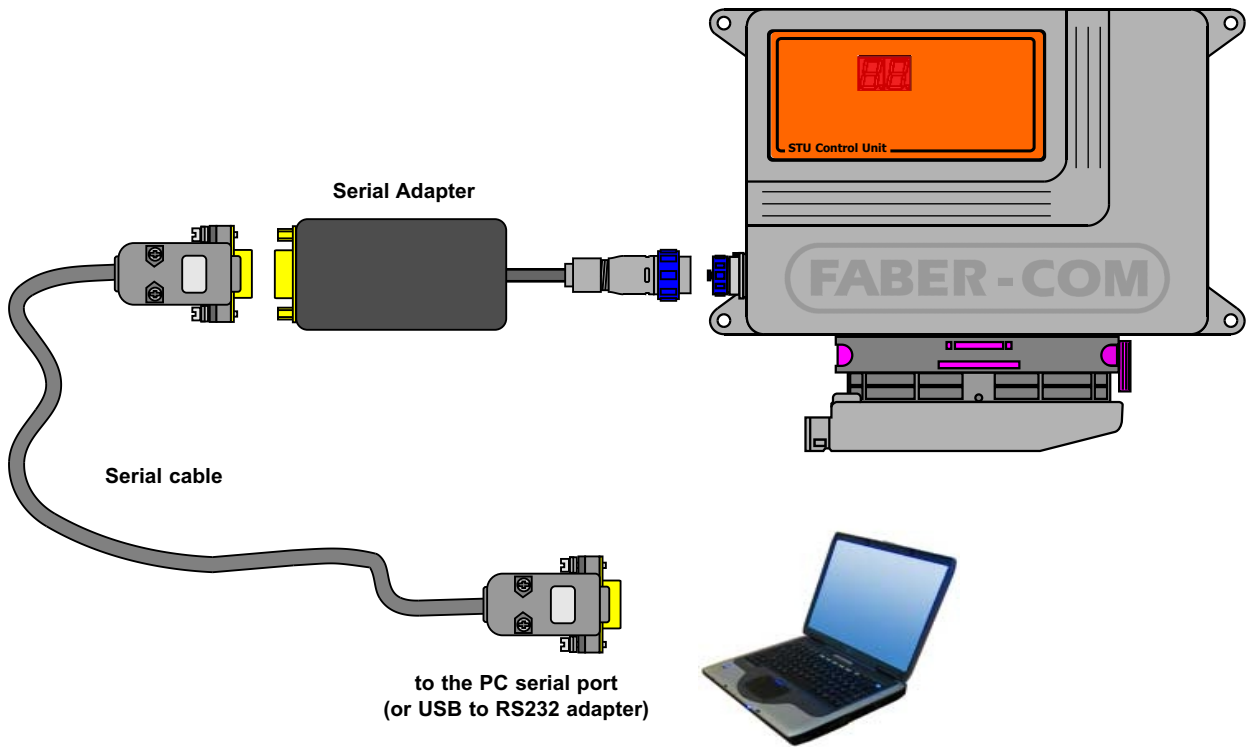

PC INTERFACE PROGRAM MAIN PAGE

SepSim-Lite 2.0.6 - [R:\Cfg\Stu\STU_PWM_01_NVD2_24V_sim2_inglese.cfg]

File Edit Option Help

Open cfg Calibration Refresh Save Upload Download Toggle COM Scroll

SCROLL

From: 0 To: 50

Delay: 250

Prev +1 +10 +100

Next -1 -10 -100

Direct Set Value
 Auto "NEXT"

	CFG file	Type	Show	Side_A	Side_B	Description
0	30 . 30	W	d	30	30	start current 1
1	30 . 30	W	d	30	30	start current 2
2	30 . 30	W	d	30	30	start current 3
3	30 . 30	W	d	30	30	start current 4
4	30 . 30	W	d	30	30	start current 5
5	30 . 30	W	d	30	30	start current 6
6	30 . 30	W	d	30	30	start current 7
7	30 . 30	W	d	30	30	start current 8
8	80 . 80	W	d	80	80	max current 1
9	80 . 80	W	d	80	80	max current 2
10	80 . 80	W	d	80	80	max current 3
11	80 . 80	W	d	80	80	max current 4
12	80 . 80	W	d	80	80	max current 5
13	80 . 80	W	d	80	80	max current 6
14	80 . 80	W	d	80	80	max current 7
15	80 . 80	W	d	80	80	max current 8
16	70 . 70	W	d	70	70	max current slow 1
17	70 . 70	W	d	70	70	max current slow 2
18	70 . 70	W	d	70	70	max current slow 3
19	70 . 70	W	d	70	70	max current slow 4
20	70 . 70	W	d	70	70	max current slow 5
21	70 . 70	W	d	70	70	max current slow 6
22	70 . 70	W	d	70	70	max current slow 7
23	70 . 70	W	d	70	70	max current slow 8
24	0 . 0	W	d	0	0	Ramp Up 1
25	0 . 0	W	d	0	0	Ramp Up 2

ON LINE | NO ACK | Index/Value = 13 / 20560 | - READY - | NORMAL MODE | COM1: