

# GENERAL APPLICATION AND SPECIFICATION INFORMATION

## APPLICATION

(SIZING AND STEERING SYSTEM DESIGN PROCESS)

### STEP ONE:

Calculate approximate kingpin torque ( $M_L$ ).

$$M_L = G \cdot \mu \sqrt{\frac{B^2}{8} + \ell^2}$$

**Note:** Double  $M_L$  if steered wheels are powered.

$M_L$  = Kingpin torque in daNm [lb-in].

$G$  = Vehicle weight on steered axle daN [lbs] (use maximum estimated overload weight).

$\mu$  = Coefficient of friction (use Chart № 1, dimensionless) determined by  $\ell/B$  (see Diagram № 1).

$B$  = Nominal width of tyre print, m [in] (see Diagram № 1).

$\ell$  = Kingpin offset. The distance between tyre centerline intersection at ground and kingpins centerline intersection at ground in, m [in] (see Diagram № 1).

Chart № 1

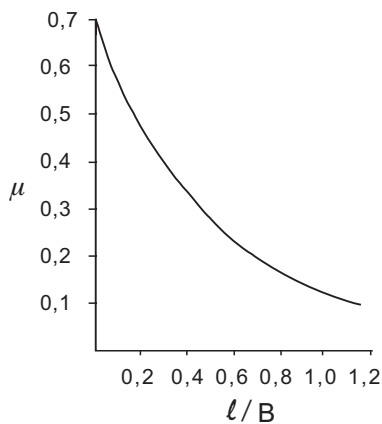

Rubber tyres on dry concrete.

Diagram № 1

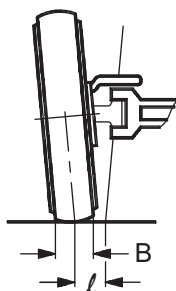
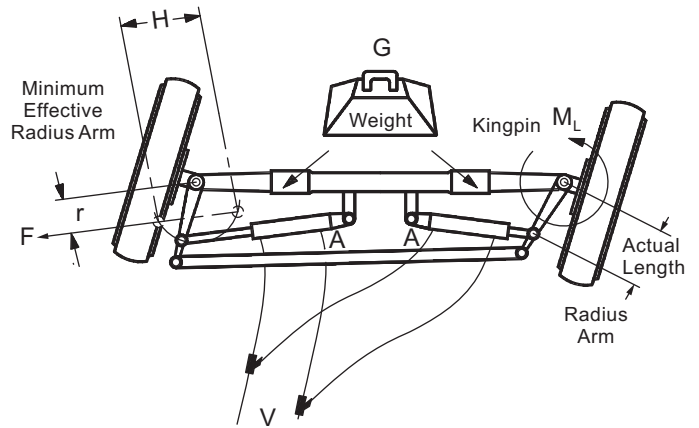

Diagram № 2



### STEP TWO:

Calculate approximate cylinder; force-area-stroke-volume.

**FORCE** 
$$F = \frac{M_L}{r}$$

$F$  = Force required daN [lbs] to steer axle.

$M_L$  = Kingpin torque in daNm [lb-in] from step one. Double  $M_L$  if steered wheels are powered.

$r$  = Effective radius Arm mm [in] is the minimum distance from the centerline of the cylinders minimum and maximum stroke points parallel to the kingpin center pivot. This is not the physical length of the radius Arm (see Diagram № 2 and Chart № 2).

Chart № 2

$$r_{\min.} = r_{\max.} \cdot \cos \frac{\gamma}{2}$$

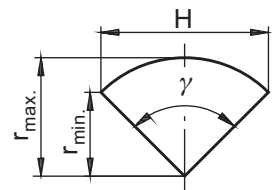

### STROKE

$H$  = Stroke, cm [in].

Calculate stroke of cylinder using Diagram № 2 and Chart № 2 as shaft.

$$H = 2 r_{\max.} \cdot \sin \frac{\gamma}{2}$$

### AREA

$$A = \frac{F}{\Delta P}$$

$A$  = Cylinder area for axle cylinder set,  $\text{cm}^2$  [in<sup>2</sup>].

$F$  = Force required from step two force formula, daN [lbs].

$\Delta P$  = Hydraulic pressure bar [PSI] use following percentage of relief valve setting by amount of load on steered axle. Severe load 25% - medium load 55% - no load 75%.

**DIAMETER**

After the cylinder set area is determined, the cylinder diameter can be calculated.

D = Inside diameter of cylinder, cm [in].  
d = Road diameter of cylinder, cm [in].

Choose type of cylinder arrangement and formula shown for that type.

**Differential Cylinder**

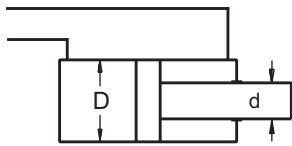

$$D = \sqrt{\frac{4A}{\pi} + d^2}$$

Note:  $\left(\frac{d}{D}\right)^2 \leq 0,15$

**Cross Connected Cylinders**

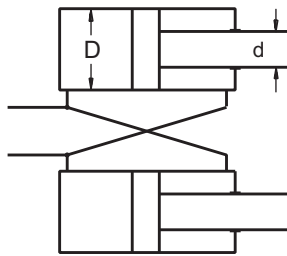

$$D = \sqrt{\frac{2A}{\pi} + \frac{d^2}{2}}$$

**Balanced Cylinder**

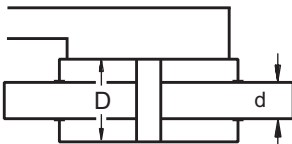

$$D = \sqrt{\frac{4A}{\pi} + d^2}$$

**Opposed Cylinder**

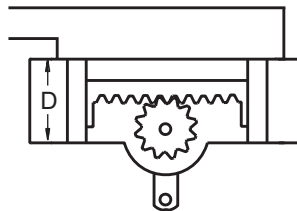

$$D = \sqrt{\frac{4A}{\pi}}$$

**VOLUME**  $V = H \cdot A$

V = Volume. The total amount of oil required to move the cylinder rod(s) through the entire stroke,  $cm^3$  [ $in^3$ ].

H = Stroke, cm [in].

A = Area,  $cm^2$  [ $in^2$ ].

**Note:** For differential cylinders it is important to calculate average cylinder volume for step three using below formula.

$$V_{avg.} = H \cdot \frac{\pi}{4} (2 \cdot D^2 - d^2)$$

**STEP THREE:**

**Selecting displacement of hydrostatic steering unit.**

At this point determine number of steering wheel revolutions desired for your application to steer the wheels from one side to the other (lock to lock). Depending on the type of vehicle and its use, this will vary from 3 to 5 turns.

**DISPLACEMENT**  $V_D = \frac{V}{n}$

$V_D$  = Displacement,  $cm^3/rev$  [ $in^3/rev$ ].

V = Volume of oil,  $cm^3$  [ $in^3$ ].

n = Steering wheel turns lock to lock.

After completing the above displacement calculation, choose the closest standard hydrostatic steering unit in displacement size that incorporates circuitry you require.

Recalculate the number of steering wheel turns using the displacement of selected standard hydrostatic steering unit outlined above. Use the formula shown below.

$$n = \frac{V}{V_D}$$

V = Volume of oil,  $cm^3$  [ $in^3$ ].

n = Steering wheel turns lock to lock.

**Note:** For differential cylinders applications the cylinder volume will be different for left and right turns - this means the value n (steering wheel turns lock to lock) will vary when turning to the left or right.

**STEP FOUR:**

**Calculate approximate minimum and maximum steering circuit flow requirements.**

$$Q = \frac{V_D \cdot N}{\text{Unit Conversion for Imperial or [1000] Metric}}$$

Q = Steering circuit flow, lpm [GPM].

$V_D$  = Unit displacement,  $cm^3/rev$  [ $in^3/rev$ ]

N = Steering wheel input speed, RPM.

Recommended steering speed is 50 to 100 RPM.

Many variables are involved in sizing the pump. We suggest that the manufacturer should test and evaluate for the desired performance.

**GENERAL INFORMATION**

**FLUID DATA:**

To insure maximum performance and life of the Hydrostatic steering units, use premium quality hydraulic oils. Fluids with effective quantities of anti-wear agents or additives are highly recommended. If using synthetic fluids consult the factory for alternative seal materials.

• **Viscosity**

Viscosity at normal operating temperature should be approx. 20  $mm^2/s$  [100 SUS]. Viscosity range 10 - 300  $mm^2/s$  [60 - 1500 SUS].

• **Temperature**

Normal operating temperature range from +30°C [+85°F] to +60°C [140°F].

Minimum operating temperature -40°C [-40°F].

Maximum operating temperature +80°C [+176°F].

**Note:** Extended periods of operation at temperature of 60°C and above will greatly reduce the life of the oil due to oxidation and will shorten the life of the product.

**Filtration**

The maximum degree of contamination per ISO 4406 or CETOP RP is:

- 20/17 open center units
- 19/16 closed center and load sensing
- 16/12 priority valves

Return line filtration of 25  $\mu m$  nominal (40 - 50  $\mu m$  absolute) or finer is recommended.

In extremely dusty conditions filtration of 10  $\mu m$  absolute should be used.

**START UP**

All air must be purged from system before operating unit. It is extremely important that any external lines or units with load sensing or priority feature be completely bled. Lines going to and from cylinders as well as lines to and from pump be purged of all air. It is recommended that a 10-15  $\mu m$  filter be used between pump and steering unit before start up.

**MOUNTING UNITS**

All hydrostatic steering units should be installed for ease of access. It is recommended that the steering unit be located outside the vehicle cabin.

It is important that no radial axial load be applied to the hydrostatic steering unit input shaft. Some or all radial and axial loads must be absorbed by the steering column or other operating devices supplied by the vehicle manufacturer.

Ports on the steering cylinder(s) should face upward to prevent damage.

During installation of the hydrostatic steering unit, cleanliness is of the utmost importance. Pipe plugs should be left in place during mounting and only removed when hydraulic lines are to be connected.

**CONVERSIONS**

**to convert inches and millimeters:**

- 1 in = 25,4 mm
- 1 mm = .03973 in

**to convert gallons per minute and liters per minute:**

- 1 GPM = 3,785 lpm
- 1 lpm = .2642 GPM

**to convert pounds per square inch and bar:**

- 1 PSI = 0,0689 bar
- 1 bar = 14.51 PSI

**to convert pounds-inch and newton-meters:**

- 1 lb-in = 0,113 Nm
- 1 Nm = 8.85 lb-in

**TORQUE TIGHTENING VALUES**

**Fluid connections**

Fluid connection	Max. tightening torque daNm [lb-in]			
	metal edge	copper washer	aluminum washer	O - ring
G 1/4	4,0 [350]	3,5 [309]	3,5 [309]	
G 3/8	7,0 [620]	4,5 [398]	5,0 [442]	
G 1/2	10,0 [885]	5,5 [486]	8,0 [708]	
G 3/4	18,0 [1593]	9,0 [796]	13,0 [1150]	
M 10 x 1	4,0 [350]	2,0 [180]	3,0 [265]	
M 18 x 1,5	8,0 [708]	5,5 [486]	7,0 [620]	
M 22 x 1,5	10,0 [885]	6,5 [575]	8,0 [708]	
7/16 - 20 UNF				2,0 [180]
9/16 - 18 UNF				5,0 [442]
3/4 - 16 UNF				6,0 [531]
7/8 - 14 UNF				9,0 [796]
1 1/16 - 12 UN				12,0 [1062]

**Mounting bolts**

Mounting bolts	Tightening torque daNm [lb - in]
3/8 - 16 UNC	3,0 ± 0,5 [230 ÷ 310]
M 10 x 1	6,5 ± 0,5 [540 ÷ 620]
M 10	3,0 ± 0,5 [230 ÷ 310]

# WARRANTY

M+S Hydraulic warrants, that its products, supplied directly to original equipment manufacturer, authorized distributor or other customer, will be free of defects in material or workmanship at the time of shipment from M+S Hydraulic and will conform to the products technical documentation (drawings and specifications) under sale agreement with Buyer.

This warranty will apply only to defects appearing within applicable Warranty period, mentioned below. If Buyer notifies M+S Hydraulic within the Warranty period about any such defects, M+S, at its sole option will replace or repair the defective products or their parts found by M+S Hydraulic to be defective in material or workmanship.

THE FOREGOING LIMITED WARRANTY IS AVAILABLE ONLY IF "M+S HYDRAULIC" IS PROMPTLY NOTIFIED IN WRITTEN OF THE ALLEGED DEFECT AND DOES NOT COVER FAILURE TO FUNCTION CAUSED BY DAMAGE TO THE PRODUCT, IMPROPER INSTALLATION, UNREASONABLE USE OR ABUSE OF THE PRODUCT, FAILURE TO PROVIDE OR USE OF IMPROPER MAINTENANCE OR USUAL, DEGRADATION OF THE PRODUCT DUE TO PHYSICAL ENVIRONMENTS OF AN USUAL NATURE. THE FOREGOING REMEDIES ARE THE SOLE AND EXCLUSIVE REMEDIES AVAILABLE TO CUSTOMER. To facilitate the inspection, M+S Hydraulic may require return of the product/part, which Buyer claims to be defective.

M+S Hydraulic shall not be liable for labor costs or any other expenses incurred during the disassembling or reinstalling of the product/part.

In case the claimed products are returned to M+S Hydraulic in bad condition: dirty, disassembled, with damaged or missing parts during transportation, the warranty will be considered as not applicable and the products will not be liable to repair.

## Warranty periods

**New products:** The Warranty period is limited to 24 consecutive months (2 years) from the date of production of the product.

**Repaired products:** If the product is repaired in M+S Hydraulic during its warranty period, the warranty period of the repaired item shall continue for the balance of original Warranty period or for a period equal to 50% of the original new product Warranty period, whichever is later.

**Spare parts:** The Warranty period for Spare parts is 12 consecutive months (1 year) from the dispatch date of such parts from M+S Hydraulic.

**LIMITATION OF LIABILITY** M+S Hydraulic's liability for claim of any kind, for loss or damage arising out of, connected with or resulting from an order, or from the performance or branch thereof, or from the design, manufacture, sale delivery, operation or use of any of its products shall be limited to, at M+S 's sole option, replacement, repair of any defective product or the issuance of a credit to Customer against any future purchases. Cash refunds will not be made under any circumstances and Customer will not be entitled to recover any damages of any kind against M+S Hydraulic, including but not limited to incidental or consequential damages, whether direct or indirect, known or unknown, foreseen or unforeseen.