



## 6/2 WAY DIRECTIONAL VALVES KV

- NG 16
- Up to 350 bar [5 076 PSI]
- Up to 250 L/min [66.04 GPM]
- Plug-in connector for solenoids to ISO 4400.
- Threaded connections to ISO 1179 (BSPP/Gas), ISO 11926 (UNF).
- Flange ports to ISO 6162-2.
- Fulfil EMC (89 / 336 / EEC).
- Protection of solenoid IP 65 to EN 60529 / IEC 60529.



KV-6/2-16-XN

### Hydraulic symbol

KV-6/2-16-...-XN

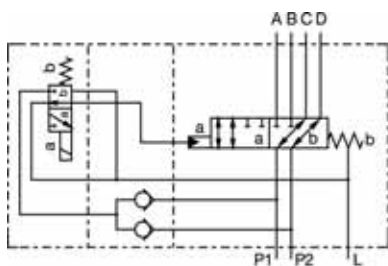

KV-6/2-16-...-N

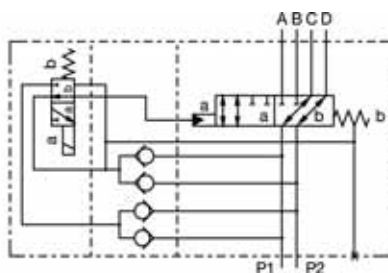

KV-6/2-16-...-Z

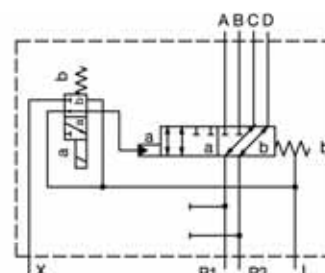

### Features

Hydraulic		
Size		16
Flow rate	L/min [GPM]	250 [66]
Operating pressure	(in port L or in return way)	15 to 350 [217.56 to 5076.32]
		250 [3625.94]
Oil temperature range	°C [°F]	-20 to +70 [-4 to 158]
Viscosity range	mm <sup>2</sup> /s [SUS]	15 to 380 [3.24 to 82]
Mounting position		Optional
Mass	kg [lb]	22 [48.50]
Filtration	NAS 1638	8

Electrical		
Supply voltage	V	12, 24 DC
Power		29
	(12 V DC supply voltage)	36
Switching frequency	1/h	15 000
Ambiant temperature	°C [°F]	to +50 [to +122]
Coil temperature	°C [°F]	to +180 [to +356]
Duty cycle		Continuous

Mechanically operated

Hydraulically operated

Electrically operated



**Dimensions**

**KV-6/2-16-...-G1/G1/4**

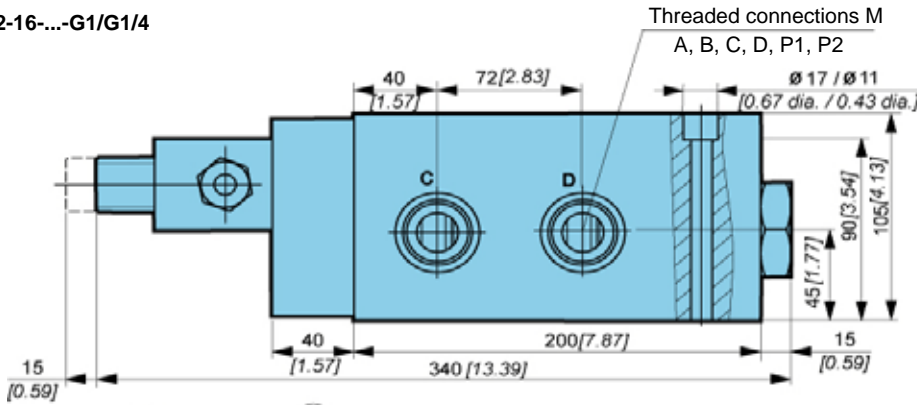

1. Emergency manual override
2. Solenoid "a" MR-045
3. Plug-in connector «a» - grey
4. Nameplate

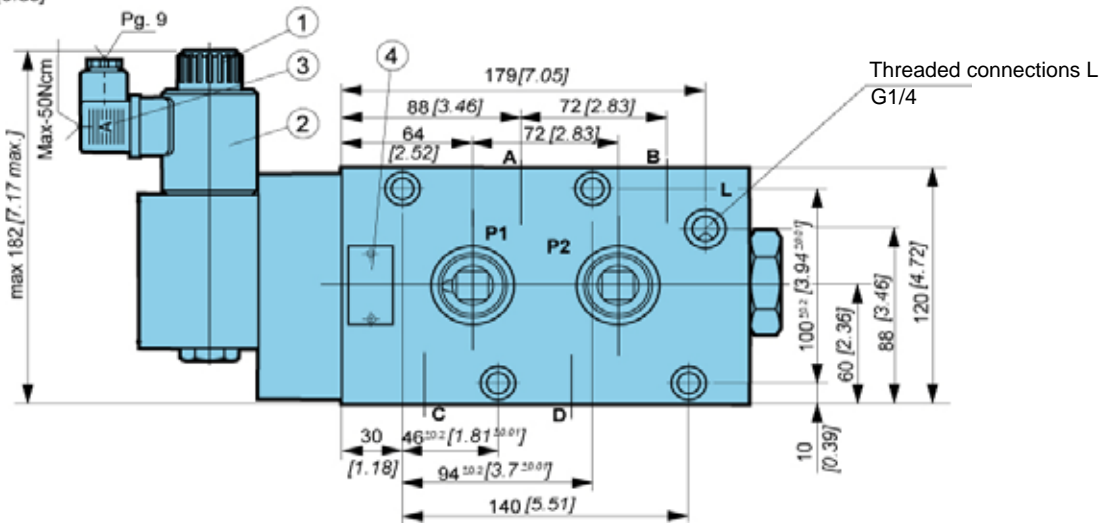

**KV-6/2-16-...-SAE...**

	Size	
	SAE 3/4	SAE 1
<b>a</b>	50.8 [2]	57.2 [2.25]
	23.8 [0.94]	
<b>b</b>		27.8 [1.09]
<b>M1</b>	M10	M12

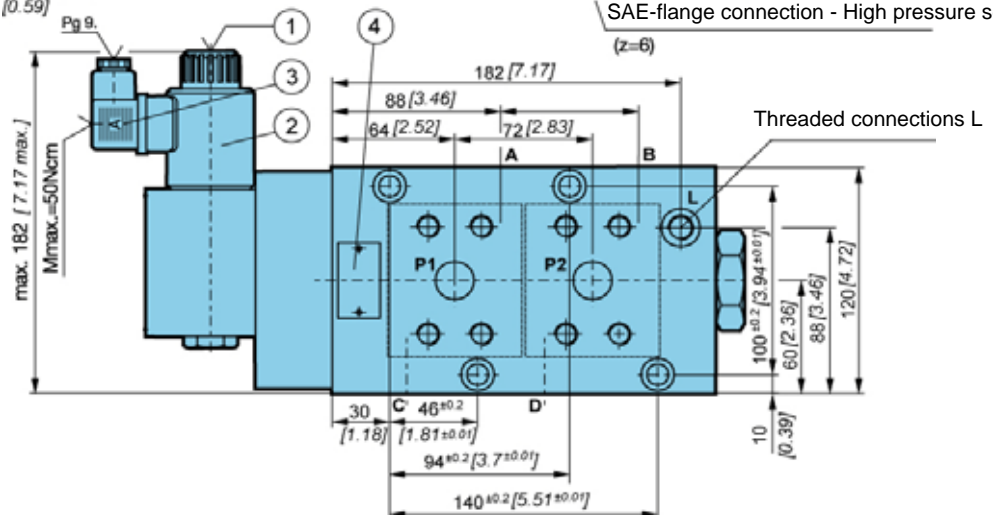
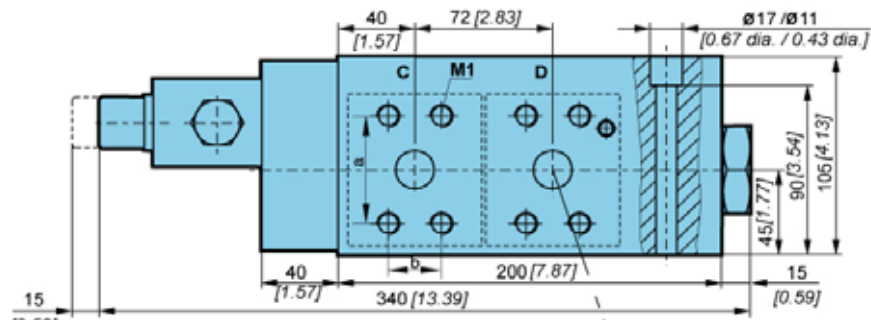

1. Emergency manual override
2. Solenoid "a" MR-045
3. Plug-in connector «a» - grey
4. Nameplate



**ΔP-Q Performance curves**

Measured at 50°C [122°F] and viscosity of 32 mm<sup>2</sup>/s [148 SUS].

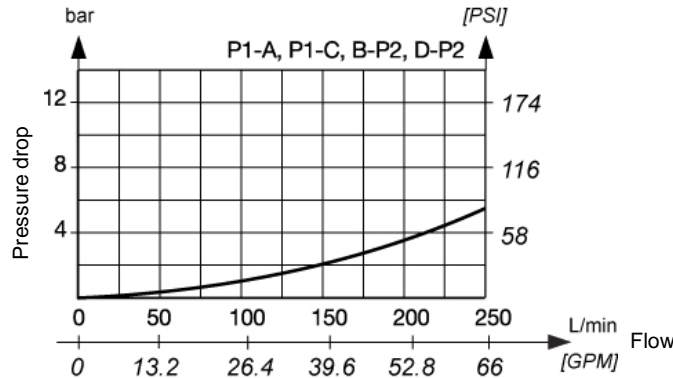

**Model code**

**K V - 6 / 2 - 16 - [ ] - [ ] - [ ] - [ ] - [ ] - [ ] - [ ] - \***

**Pilot oil supply and discharge**

Internal x, y	<b>N</b>
Internal, external y (port L)	<b>XN</b>
external, external	<b>Z</b>

**Threaded connections M ; L**

G1 ; G1/4	<b>G1/G1/4</b>
1 5/16-12 UNF-2B ; 9/16-18 UNF-2B	<b>SAE 16</b>
SAE-Flange connections 3/4 - high pressure series	<b>SAE3/4</b>
SAE-Flange connections 1 - high pressure series	<b>SAE1</b>

**Manual override option**

Emergency manual override	<b>No designation</b>
Manual override with rubber cover	<b>G</b>
Lockable manual override	<b>C</b>

**supply voltage**

direct voltage 24 V	<b>No designation</b>
direct voltage 12 V	<b>12 DC</b>

**Connector type**

EN 175301-803 without signal lamp	<b>No designation</b>
EN 175301-803 with signal lamp	<b>L</b>
G1/2 (YZ=G1/4) without connector	<b>K</b>
AMP junior timer without connector	<b>M</b>
Deutsch	<b>V</b>

**Overvoltage protection**

without overvoltage protection	<b>No designation</b>
with overvoltage protection	<b>T</b>

**Seal type**

NBR seals for mineral oil HL, HLP to DIN 51524	<b>No designation</b>
FPM seals for HETG, HEES, HEPG to VDMA 24568 and ISO 15380	<b>E</b>

**Special requirements to be briefly specified**

Mechanically operated

Hydraulically operated

Electrically operated