



AIRWORK microcylinders ISO 6432 are manufactured according to the european DIN/ISO norme, and have bores from 8 to 25 mm. The heads are fixed to the tube through a process of rolling. They are available in different versions: single/double acting, magnetic, cushioned. A complete range of fixing accessories is available, and the production of special cylinders on customer's drawing is possible.

Les microvérins AIRWORK sont conformes à la norme européenne DIN/ISO 6432, et ils vont du diamètre 8 jusqu'à 25 mm. Différentes versions et accessoires sont disponibles: simple ou double effet, magnétique ou non, avec ou sans bloqueur.

Une liste complète d'accessoires est disponible et nous pouvons également créer des vérins spéciaux selon la conception du client

I microcilindri AIRWORK sono realizzati secondo le normative europee DIN/ISO 6432 ed hanno alesaggi compresi tra 8 e 25 mm. Le testate sono fissate alla camicia mediante rullatura. Sono realizzabili in differenti versioni, semplici e doppio effetto, magnetici, Ammortizzati. Sono inoltre disponibili i relativi accessori di fissaggio ed esecuzioni speciali a disegno.

ORDERING CODE / CODIFICATION / CHIAVE DI CODIFICA

M C 3 0 0 0 M 0 0 0 0 0

- Stroke / **Course** / *Corsa*
- Ø cylinder / **Ø vérin** / *Ø cilindro*
- M= Magnetic / **Magnétique** / *Magnetico*
0= Non magnetic / **Non magnétique** / *Non magnetico*
- **VERSION / VERSION / VERSIONE**
16= Single acting front spring / **Simple effet tige rentrée** / *Semplice effetto molla anteriore*
17= Single acting rear spring / **Simple effet tige sortie** / *Semplice effetto molla posteriore*
18= Double acting / **Double effet** / *Doppio effetto*
19= Double acting with cushioning / **Double effet amorti** / *Doppio effetto con ammortizzo*
20= Double acting through rod / **Double effet tige traversante** / *Doppio effetto stelo passante*
21= Double acting through rod with cushioning / **Double effet tige traversante amorti** / *Doppio effetto stelo passante con amm.*
22= Double acting for rod lock / **Double effet pour bloqueur de tige** / *Doppio effetto con extrastelo per bloccastelo*
24= Double acting with rod lock / **Double effet avec bloqueur de tige** / *Doppio effetto con bloccastelo*
25= Double acting cushioning with rod lock / **D.e. amorti avec bloqueur de tige** / *Doppio effetto con ammortizzo con bloccastelo*
- **SEALS / JOINTS / GUARNIZIONI**
0= Standard / **Standard** / *Standard* (-20°C / +80°C)
2= High temperature / **Haute température** / *Alta temperatura* (-10°C / +150°C)
3= Low friction / **Faible frottement** / *Basso attrito*
4= Viton on the rod only / **Viton sur la tige uniquement** / *Viton solo sullo stelo*
7= Low temperature / **Basse température** / *Bassa temperatura* (-40°C / +80°C)
- **VERSION / VERSION / VERSIONE**
3= Standard / **Standard** / *Standard*
5= Feeding in axis - rear part / **Alimentation dans l'axe arrière** / *Alimentazione in asse parte posteriore*
6= Anti rotation rod / **Antirotation tige hexagonale** / *Antirotazione stelo esagonale*
7= Short series without rear thread / **Série courte sans filetage arrière** / *Serie corta senza filetto posteriore*



On request ATEX version:
Sur demande version ATEX:
Su richiesta versione ATEX:
Ex II 2G Ex h II c T5 Gb
Ex II 2D Ex h III c T100°C Db

VERSION / VERSIONE / VERSION

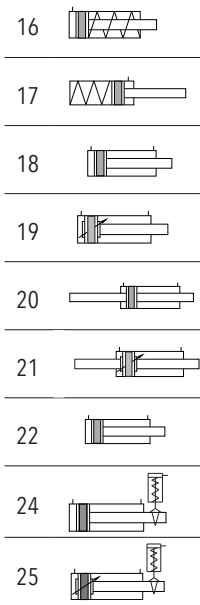

STANDARD STROKES / COURSES STANDARD / CORSE STANDARD

Double acting / **Double effet** / *Doppio effetto*

Ø8	mm 10-25-50-80-100-125
Ø10	mm 10-25-50-80-100-125
Ø12	mm 10-25-50-80-100-125-160-200
Ø16	mm 10-25-50-80-100-125-160-200-250
Ø20	mm 10-25-50-80-100-125-160-200-250-320
Ø25	mm 10-25-50-80-100-125-160-200-250-320

Cushioning / **Avec amortissement** / *Ammortizzato*

Ø16	mm 10-25-50-80-100-125-160-200-250
Ø20	mm 10-25-50-80-100-125-160-200-250-320
Ø25	mm 10-25-50-80-100-125-160-200-250-320

Single acting / **Simple effet** / *Semplice effetto*

Ø8	mm 10-25-50
Ø10	mm 10-25-50
Ø12	mm 10-25-50
Ø16	mm 10-25-50
Ø20	mm 10-25-50
Ø25	mm 10-25-50

TECHNICAL DATA / DONNÉES TECHNIQUES / DATI TECNICI

Fluid / Fluide / <i>Fluido</i>	Lubricated or non lubricated air / Air lubrifié ou non lubrifié / <i>Aria con o senza lubrificazione</i>
Operating temperature range / Température d'utilisation / <i>Temp. di esercizio</i>	(-20°C / +80°C) (-10°C / +150°C) (-40°C / +80°C)
Max operating pressure / Pression maximum / <i>Pressione massima di esercizio</i>	10 bar
Force / Force / <i>Forze sviluppate</i>	Technical informations page / Page informations techniques / <i>Pagina dati tecnici</i>
Air consumption / Consommation d'air / <i>Consumo aria</i>	Technical informations page / Page informations techniques / <i>Pagina dati tecnici</i>

THEORETICAL FORCES AT 6 BAR / FORCE THÉORIQUE À 6 BAR / FORZA TEORICA A 6 BAR

	Thrust force (N) / Force de poussée (N) / Forza di spinta (N)	Traction force (N) / Force de traction (N) / Forza di trazione (N)
Ø8	30	23
Ø10	47	40
Ø12	68	51
Ø16	121	104
Ø20	180	158
Ø25	295	247

THEORETICAL FORCE OF SPRINGS / FORCE THÉORIQUE DES RESSORTS / FORZA TEORICA DELLE MOLLE

Stroke / Course / <i>Corsa</i>	Front spring / Ressort avant / <i>Molla anteriore</i>						Rear spring / Ressort arrière / <i>Molla posteriore</i>					
	10mm		25mm		50mm		10mm		25mm		50mm	
Force / Force / <i>Forza</i> *	F1 (N)	F2 (N)	F1 (N)	F2 (N)	F1 (N)	F2 (N)	F1 (N)	F2 (N)	F1 (N)	F2 (N)	F1 (N)	F2 (N)
Ø8	4.1	4.6	3.4	4.6	2.2	4.6	5.5	6	4.8	6	3.6	6
Ø10	4.1	4.6	3.4	4.6	2.2	4.6	5	6.2	3.3	6.2	3.3	6.2
Ø12	5.6	6	5.5	6	4.1	6	13	14.2	11.3	14.2	8.5	14.2
Ø16	19.2	21.5	15.7	21.5	9.8	21.5	19	20.7	16.3	20.7	12	20.7
Ø20	20.4	22.5	17.3	22.5	11.7	22.5	57.2	61.5	50.7	61.5	39.8	61.5
Ø25	17.5	18.8	15.6	18.8	12.4	18.8	28.5	30.6	25.3	30.6	19.8	30.6

*

F1 = Extended spring force / **Force de ressort étendue** / *Forza molla estesa*

F2 = Compressed spring force / **Force du ressort comprimé** / *Forza molla compressa*

COMPONENTS / COMPOSANTS / COMPONENTI

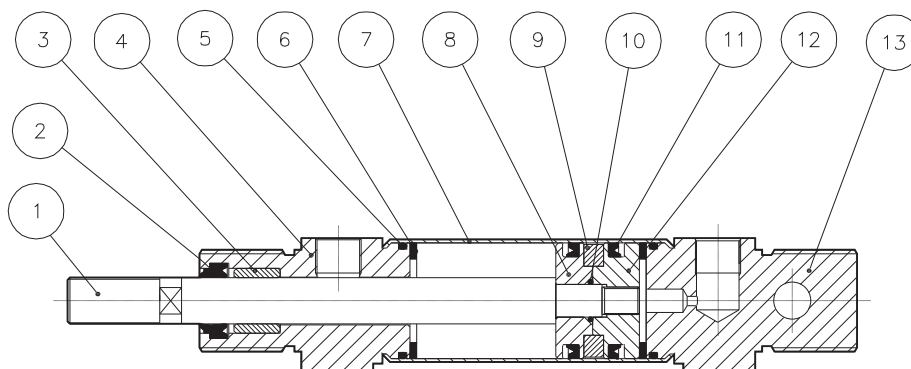

N.	DESCRIPTION / DESCRIPTION / <i>DESCRIZIONE</i>	MATERIAL / MATIÈRE / <i>MATERIALE</i>
1	rod / tige / <i>stelo</i>	stainless steel AISI 303 / acier AISI 303 / <i>acciaio inox 303</i>
2	rod seal / joints tige / <i>guarnizione stelo</i>	polyurethane / polyuréthane / <i>poliuretano</i>
3	guide bush / bague guidage / <i>bussola guida</i>	bronze / bronze / <i>bronzo</i>
4	front cap / fond antérieur / <i>testata anteriore</i>	aluminium / aluminium / <i>alluminio</i>
5	o-ring / joint torique	NBR
6	bumper / butoir / <i>paracolpo</i>	NBR
7	tube / tube / <i>tube</i>	stainless steel AISI 304 / acier AISI 304 / <i>acciaio inox 304</i>
8	piston / piston / <i>pistone</i>	brass / cuivre / <i>ottone</i>
9	magnet / aimant / <i>magnete</i>	plastroferrite
10	o-ring / joint torique	NBR
11	seal piston / joints piston / <i>guarnizione pist.</i>	polyurethane / polyuréthane / <i>poliuretano</i>
12	piston / piston / <i>pistone</i>	brass / laiton / <i>ottone</i>
13	rear cap / fond postérieur / <i>testata post.</i>	aluminium / aluminium / <i>alluminio</i>

Single acting front spring
Simple effet tige rentrée
Semplice effetto molla anteriore

CODE: MC3016M.Ø.mm

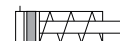

CODE: MC30160.Ø.mm

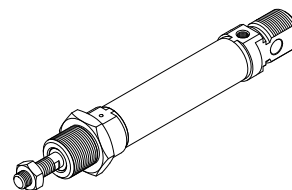
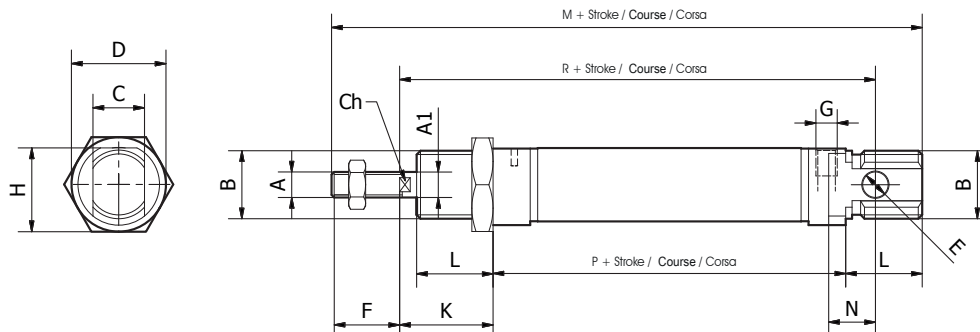
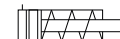

Ø	A	A1	B	C	D	E	F	G	H	K	L	M	P	R	CH
8	M4	4	M12x1.25	8	16	4	12	M5	15	16	12	86	46	64	-
10	M4	4	M12x1.25	8	16	4	12	M5	15	16	12	86	46	64	-
12	M6	6	M16x1.5	12	19	6	16	M5	18	22	18	104	48	75	5
16	M6	6	M16x1.5	12	19	6	16	M5	18	22	18	109	53	82	5
20	M8	8	M22x1.5	16	27	8	20	1/8 G	25.5	24	20	131	67	95	7
25	M10x1.25	10	M22x1.5	16	30	8	22	1/8 G	28.5	28	22	140	68	104	9

Single acting rear spring
Simple effet tige sortie
Semplice effetto molla posteriore

CODE: MC3017M.Ø.mm



CODE: MC30170.Ø.mm

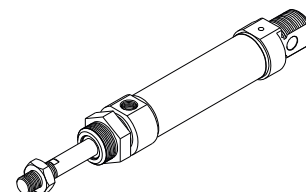
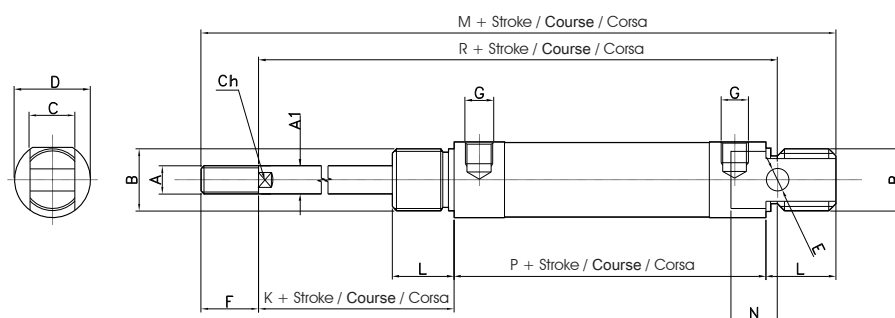

Ø	A	A1	B	C	D	E	F	G	K	L	M	N	P	R	CH
8	M4	4	M12x1.25	8	16	4	12	M5	16	12	104	6	64	82	-
10	M4	4	M12x1.25	8	16	4	12	M5	16	12	111.5	6	71.5	89.5	-
12	M6	6	M16x1.5	12	19	6	16	M5	22	18	126.5	9	70.5	97.5	5
16	M6	6	M16x1.5	12	19	6	16	M5	22	18	138	9	82	111	5
20	M8	8	M22x1.5	16	27	8	20	1/8 G	24	20	162.5	12	98.5	126.5	7
25	M10x1.25	10	M22x1.5	16	30	8	22	1/8 G	28	22	171.5	12	99.5	135.5	9

Double acting
Double effet
Doppio effetto

CODE: MC3018M.Ø.mm

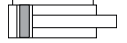

CODE: MC30180.Ø.mm

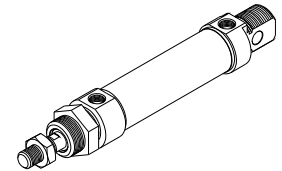
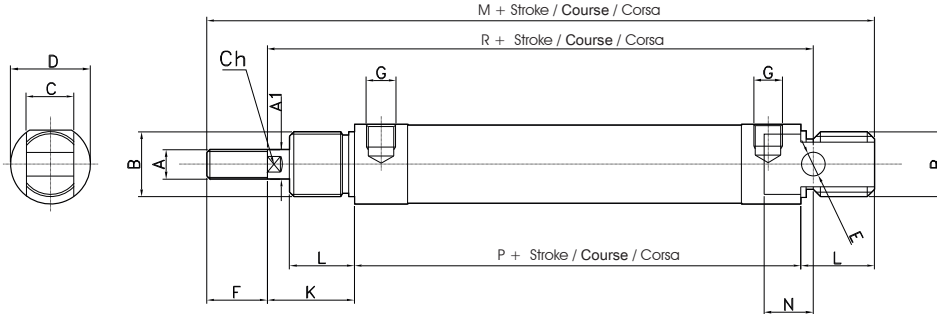
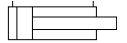

Ø	A	A1	B	C	D	E	F	G	K	L	M	N	P	R	CH
8	M4	4	M12x1.25	8	16	4	12	M5	16	12	86	6	46	64	-
10	M4	4	M12x1.25	8	16	4	12	M5	16	12	86	6	46	64	-
12	M6	6	M16x1.5	12	19	6	16	M5	22	18	104	9	48	75	5
16	M6	6	M16x1.5	12	19	6	16	M5	22	18	109	9	53	82	5
20	M8	8	M22x1.5	16	27	8	20	1/8 G	24	20	131	12	67	95	7
25	M10x1.25	10	M22x1.5	16	30	8	22	1/8 G	28	22	140	12	68	104	9

Double acting through rod
Double effet tige traversante
Doppio effetto stelo passante

CODE: MC3020M.Ø.mm

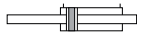

CODE: MC30200.Ø.mm

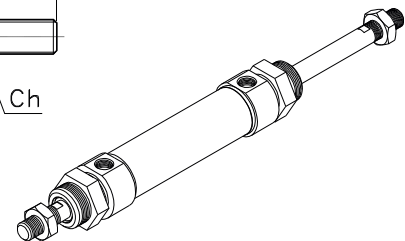
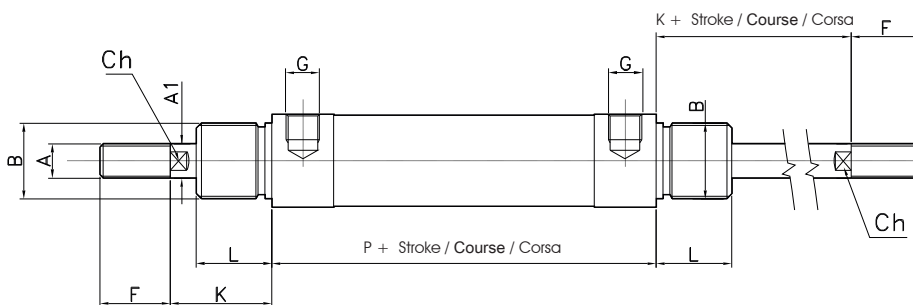
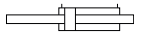

Ø	A	A1	B	D	F	K	L	P	G	CH
8	M4	4	M12x1.25	16	12	16	12	46	M5	-
10	M4	4	M12x1.25	16	12	16	12	46	M5	-
12	M6	6	M16x1.5	19	16	22	18	48	M5	5
16	M6	6	M16x1.5	19	16	22	18	53	M5	5
20	M8	8	M22x1.5	27	20	24	20	67	1/8 G	7
25	M10x1.25	10	M22x1.5	30	22	28	22	68	1/8 G	9

Double acting with cushioning
Double effet amorti
Doppio effetto con ammortizzo

CODE: MC3019M.Ø.mm

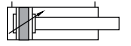

CODE: MC30190.Ø.mm

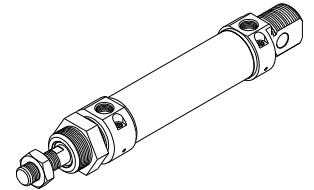
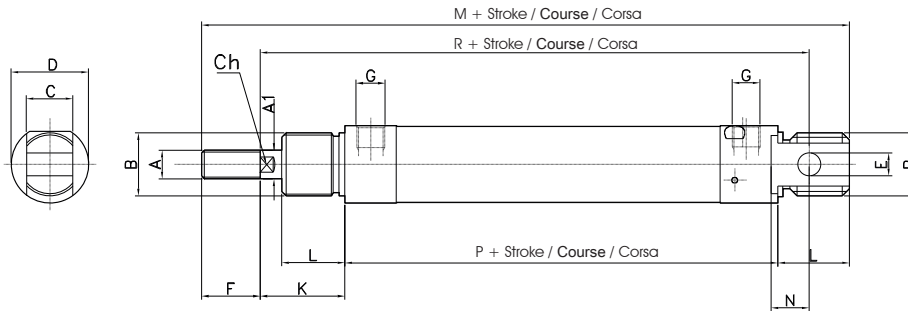
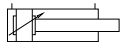

Ø	A	A1	B	C	D	E	F	G	K	L	M	N	P	R	CH
16	M6	6	M16x1.5	12	21	6	16	M5	22	17	109	9	55	82	5
20	M8	8	M22x1.5	16	27	8	20	1/8 G	24	20	131	12	67	95	7
25	M10x1.25	10	M22x1.5	16	30	8	22	1/8 G	28	22	140	12	68	104	9

Double acting through rod with cushioning
Double effet tige traversante amorti
Doppio effetto stelo passante con ammortizzo

CODE: MC3021M.Ø.mm

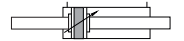

CODE: MC30210.Ø.mm

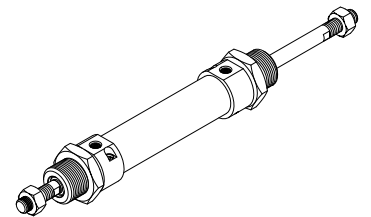
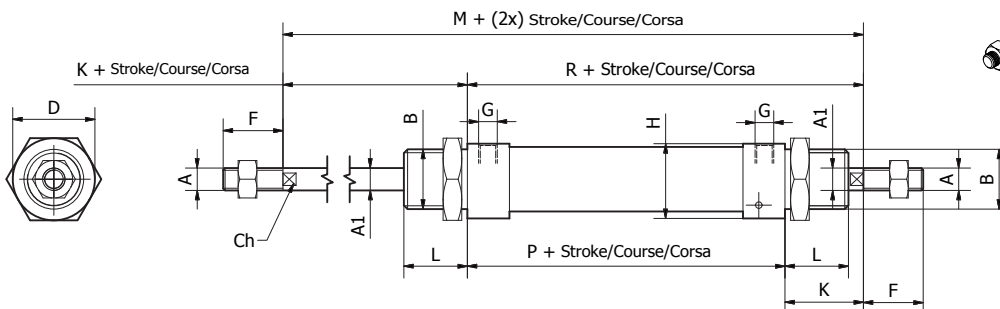

Ø	A	A1	B	D	F	G	H	K	L	M	P	R	CH
16	M6	6	M16x1.5	21	16	M5	20	22	17	97	53	76	5
20	M8	8	M22x1.5	27	20	1/8	25.5	24	20	115	67	91	7
25	M10x1.25	10	M22x1.5	30	22	1/8	28.5	28	22	124	68	96	9

Double acting feeding in axis - rear part
Double effet alimentation arrière dans l'axe
Doppio effetto alimentazione in asse parte posteriore

CODE: MC5018M.Ø.mm 

CODE: MC50180.Ø.mm 

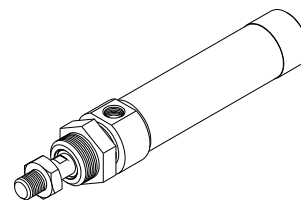
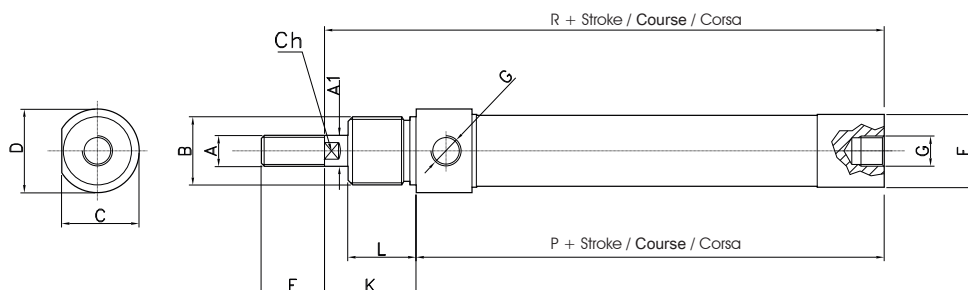

Ø	A	A1	B	C	D	E	F	G	K	L	P	R	CH
16	M6	6	M16x1.5	18	19	17.2	16	M5	22	18	52	74	5
20	M8	8	M22x1.5	25.5	27	22.2	20	1/8 G	24	20	65	89	7
25	M10x1.25	10	M22x1.5	28.5	30	27	22	1/8 G	28	22	66	94	9

Single acting front spring feeding in axis - rear part
Simple effet tige rentrée alimentation dans l'axe arrière
Semplice effetto molla anteriore alimentazione in asse parte posteriore

CODE: MC5016M.Ø.mm 

CODE: MC50160.Ø.mm 

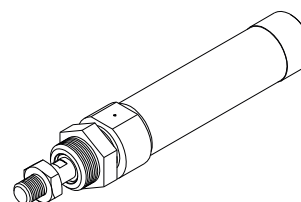
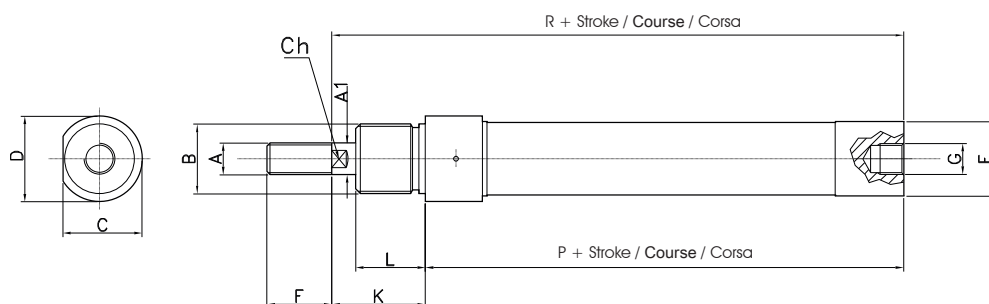

Ø	A	A1	B	C	D	F	G	K	L	P	R	CH
16	M6	6	M16x1.5	18	19	16	M5	22	18	52	74	5
20	M8	8	M22x1.5	25.5	27	20	1/8 G	24	20	65	89	7
25	M10x1.25	10	M22x1.5	28.5	30	22	1/8 G	28	22	66	94	9

Double acting short series without rear thread
Double effet série courte sans filetage arrière
Doppio effetto serie corta senza filetto posteriore

CODE: MC7018M.Ø.mm

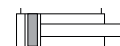

CODE: MC70180.Ø.mm

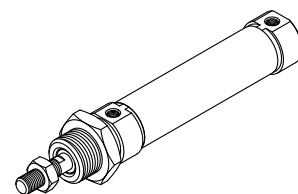
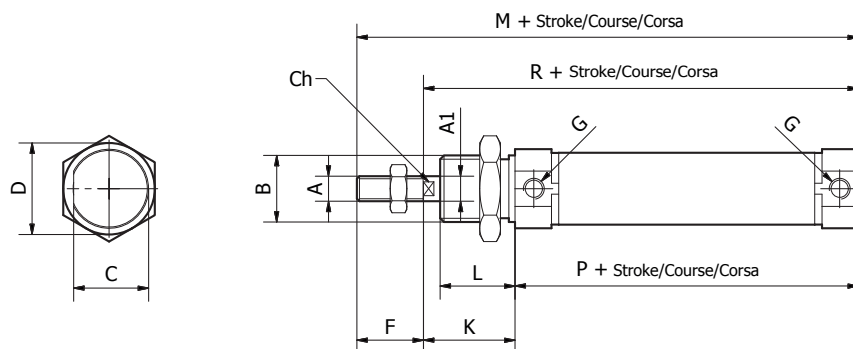
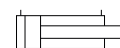

Ø	A	A1	B	C	D	F	G	K	L	M	P	R	CH
16	M6	6	M16x1.5	18	19	16	M5	22	18	90	52.5	74.5	5
20	M8	8	M22x1.5	25.5	27	20	1/8 G	24	20	111	67	91	7
25	M10x1.25	10	M22x1.5	28.5	30	22	1/8 G	28	22	118	68	96	9

Single acting front spring short series without rear thread
Simple effet tige rentrée série courte sans filetage arrière
Semplice effetto molla anteriore serie corta senza filetto posteriore

CODE: MC7016M.Ø.mm



CODE: MC70160.Ø.mm

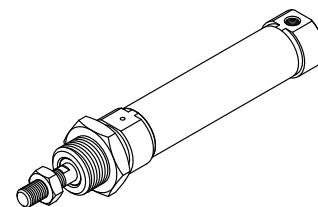
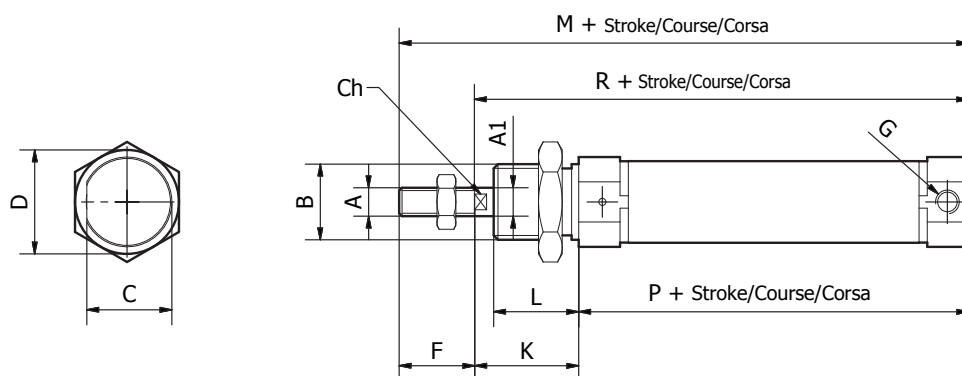

Ø	A	A1	B	C	D	F	G	K	L	M	P	R	CH
16	M6	6	M16x1.5	18	19	16	M5	22	18	90	52.5	74.5	5
20	M8	8	M22x1.5	25.5	27	20	1/8 G	24	20	111	67	91	7
25	M10x1.25	10	M22x1.5	28.5	30	22	1/8 G	28	22	118	68	96	9

Double acting anti rotation rod
Double effet antirotation tige hexagonale
Doppio effetto antirotazione tige esagonale

CODE: MC6018M.Ø.mm



CODE: MC60180.Ø.mm

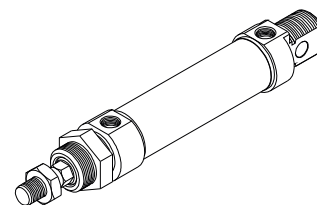
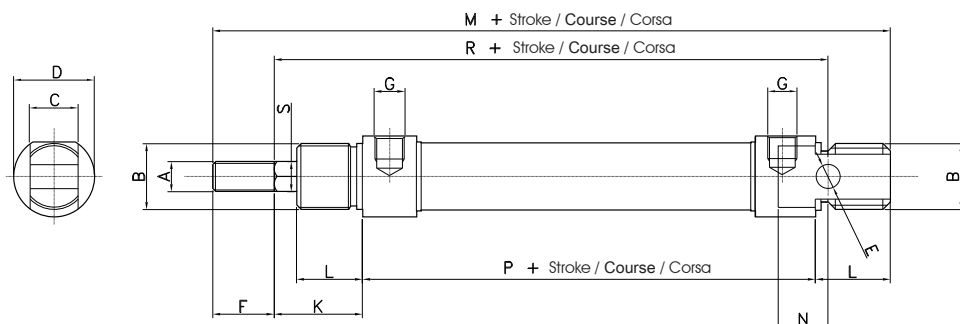

Ø	A	A1	B	C	D	E	F	G	K	L	M	N	P	R	CH
16	M6	6	M16x1.5	12	19	6	16	M5	22	18	109	9	53	82	6
20	M8	8	M22x1.5	16	27	8	20	1/8 G	24	20	131	12	67	95	8
25	M10x1.25	10	M22x1.5	16	30	8	22	1/8 G	28	22	140	12	68	104	10

Double acting with rod lock
Double effet avec bloqueur de tige
Doppio effetto con bloccastelo

CODE: MC2418M.Ø.mm

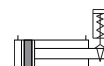

CODE: MC24180.Ø.mm

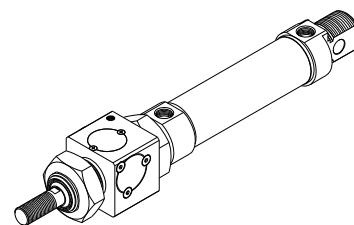
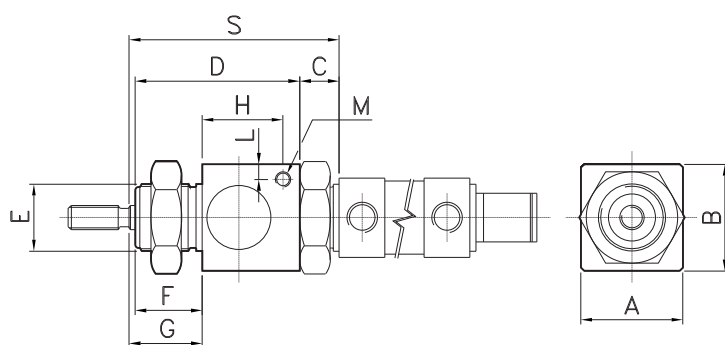

Ø	A	B	C	D	E	F	G	H	L	M	S
20	34	35	13	54	M22x1.5	22	26	27	5	M5	71
25	34	35	13	54	M22x1.5	22	26	27	5	M5	73

MOUNTING PARTS / ACCESSOIRES DE MONTAGE / ACCESSORI DI FISSAGGIO

Actuators / Actionneurs / Attuatori

CYLINDERS ISO 6432 / MICROVERINS ISO 6432 / CILINDRI ISO 6432

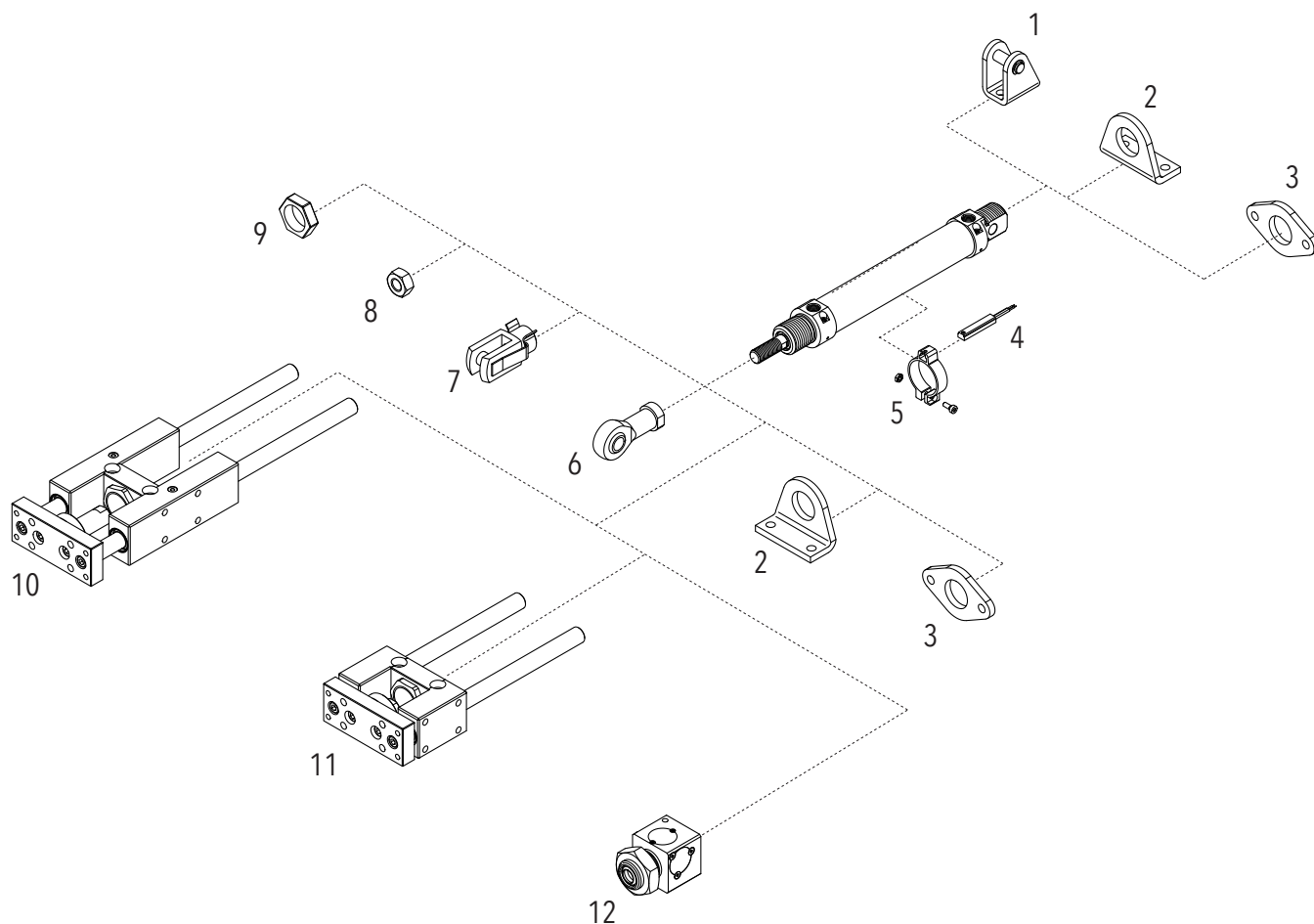

POS.	DESCRIPTION / DESCRIPTION / DESCRIZIONE	CODE / CODE / CODICE	PAGE / PAGE / PAGINA
1	Female hinge / Chape arriere / Cerniera femmina	AR4154 Ø	1.14
2	Pedestal / Equerre / Piedino	AR4155 Ø	1.14
3	Flange / Bride / Flangia	AR4157 Ø	1.14
4	T switch / Capteur en T / Sensore a T	AR4023...	1.16
5	Adaptor for T switch / Adaptateur capteur en T / Adattatore sensore a T	AR4199 Ø	1.16
6	Rod ends / Chape de tige rotulée / Testa a snodo	AR406...	1.15
7	Yoke with clip / Chape de tige / Forcella con clip	AR4067...	1.15
8	Nut for rod / Ecrou pour tige / Dado per stelo	DAN...	1.15
9	Nut for cap / Ecrou de nez / Dado per testata	DAN...	1.15
10	Guide unit H type / Unité de guidage en H / Unità guida ad H	UG2014. Ø	1.133
11	Guide unit U type / Unité de guidage en U / Unità guida ad U	UG2008. Ø	1.133
12	Rod lock / Bloqueur de tige / Bloccastelo	BS.... Ø	1.121

PEDESTAL
EQUERRE
PIEDINO

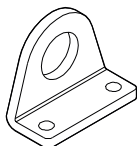

CODE MATERIAL / **MATIÈRE** / MATERIALE
AR4155 Ø Steel / **Acier** / **Acciaio**

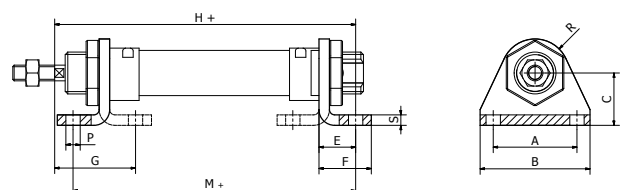

Ø	A	B	C	E	F	G	H	M	P	R	S
8-10	25	35	16	11	16	24	73	68	4.5	10	3
12	32	42	20	14	20	32	84	76	5.5	12.5	4
16	32	42	20	14	20	32	91	83	5.5	12.5	4
20	40	54	25	17	25	36	108	101	6.6	20	5
25	40	54	25	17	25	40	113	102	6.6	20	5

FLANGE
BRIDE
FLANGIA

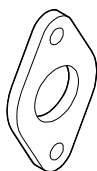

CODE MATERIAL / **MATIÈRE** / MATERIALE
AR4157 Ø Steel / **Acier** / **Acciaio**

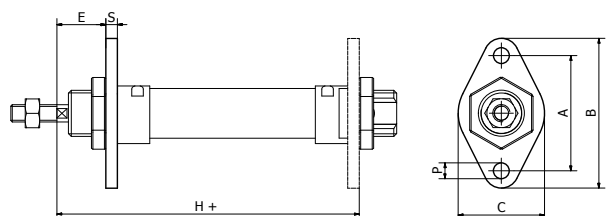

Ø	A	B	C	E	H	P	S
8-10	30	40	22	13	65	4.5	3
12	40	52	30	18	74	5.5	4
16	40	52	30	18	81	5.5	4
20	50	66	40	19	96	6.6	5
25	50	66	40	23	101	6.6	5

FEMALE HINGE
CHAPE ARRIERE
CERNIERA FEMMINA



CODE MATERIAL / **MATIÈRE** / MATERIALE
AR4154 Ø Steel / **Acier** / **Acciaio**

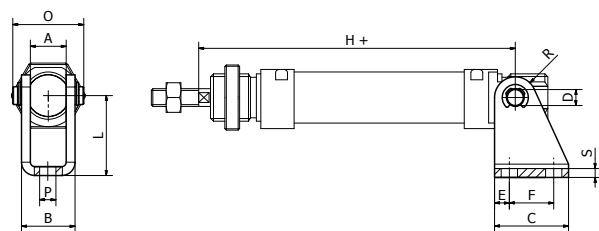

Ø	A	B	C	D	E	F	H	L	O	P	R	S
8-10	8.1	13.1	22	4	4.7	12.5	64	24	17	4.5	10	2.5
12	12.1	18.1	25	6	5	15	75	27	23	5.5	12	3
16	12.1	18.1	25	6	5	15	82	27	23	5.5	12	3
20	16.1	24.1	32	8	6	20	95	30	29.5	6.6	16	4
25	16.1	24.1	32	8	6	20	104	30	29.5	6.6	16	4

YOKE WITH CLIP
CHAPE DE TIGE
FORCELLA CON CLIP

Material: Steel
Matière: Acier
Materiale: Acciaio

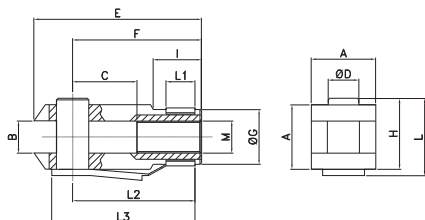
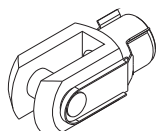

CODE	Ø
AR40670	8-10
AR40671	12-16
AR40672	20
AR40673	25

Ø	A	B	C	D	E	F	G	H	I	M	L	L1	L2	L3
8/10	8	4	8	4	21	16	8	9	6	M4	11	5	15	19
12/16	12	6	12	6	31	24	10	14	9	M6	16	6	23	28
20	16	8	16	8	42	32	14	19	12	M8	22	8	31	37
25	20	10	20	10	52	40	18	23	15	M10x1.25	26	10	39	46

ROD ENDS
CHAPE DE TIGE ROTULÉE
TESTA A SNODO

Material: Steel
Matière: Acier
Materiale: Acciaio

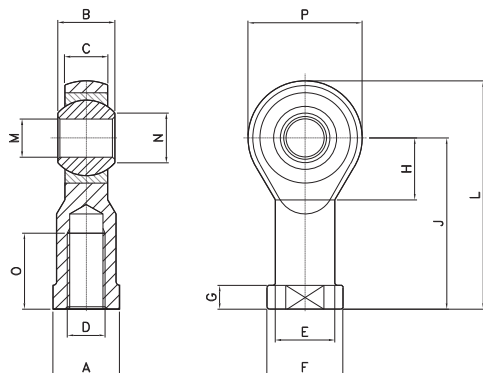

CODE	Ø
AR40655	8-10
AR40656	12-16
AR40657	20
AR40660	25

Ø	A	B	C	D	E	F	G	H	J	L	M	N	O	P
8-10	9	8	6	M4	9	11	4	10	27	36	5	7.7	10	18
12-16	11	9	6.75	M6	10	13	5	11	30	40	6	8.9	12	20
20	14	12	9	M8	12.5	16	5	13	36	48	8	10.4	16	24
25	17	14	10.5	M10x1.25	15	19	6.5	15	43	57	10	12.9	20	28

NUT FOR ROD
ECROU POUR TIGE
DADO PER STELO

Material: Steel
Matière: Acier
Materiale: Acciaio

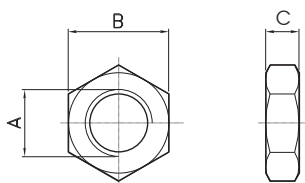

CODE	Ø	A	B	C
DAN4	8-10	M4	7	3
DAN6	12-16	M6	10	5
DAN8	20	M8	13	6.5
DAN10X1,25	25	M10x1.25	17	8

NUT FOR CAP
ECROU DE NEZ
DADO PER TESTATA

Material: Steel
Matière: Acier
Materiale: Acciaio

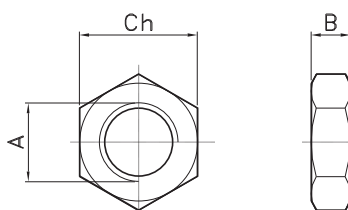

CODE	Ø
DAD12X1,25	8-10
DAD16X1,5	12-16
DAD22X1,5	20-25

Ø	A	B	Ch
8-10	M12x1.25	7	19
12-16	M16x1.5	8	24
20-25	M22x1.5	10	32

T SWITCH
CAPTEUR EN T
SENSORE AT

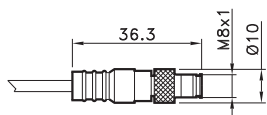
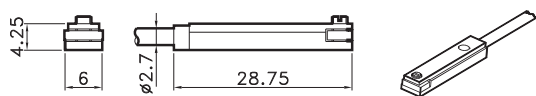

4= black / **noire** / nero
1= brown / **brun** / marrone
3= blue / **bleu** / azzurro

CODE

AR4023010	REED (MT.2,5) / REED (MT.2,5) / REED (MT.2,5)
AR4023020	HALL (MT.2,5) / HALL (MT.2,5) / HALL (MT.2,5)
AR4023110	REED + M8 (CM 30) / REED + M8 / REED + M8 (CM 30)
AR4023120	HALL + M8 (CM 30) / HALL + M8 / HALL + M8 (CM 30)

For technical data see page 1.74

Pour les données techniques, voir page 1.74

Per i dati tecnici vedere pag. 1.74

EXTENSION CABLE 2,5 mt
EXTENSION CÂBLE 2,5 mt
PROLUNGA CAVO 2,5 mt

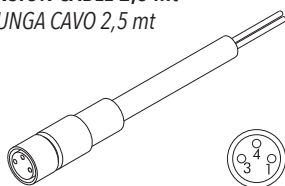

4= black / **noire** / nero
1= brown / **brun** / marrone
3= blue / **bleu** / azzurro

CODE

AR4300	WITH M8 2 WIRES / M8 AVEC 2 FILS / CON M8 2 FILI
AR4301	WITH M8 3 WIRES / M8 AVEC 3 FILS / CON M8 3 FILI

ADAPTOR FOR T SWITCH
ADAPTATEUR CAPTEUR EN T
ADATTATORE SENSORE AT

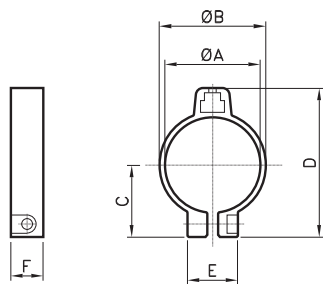
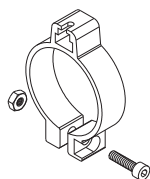

CODE

AR4199 Ø MATERIAL / **MATIÈRE** / MATERIALE
Plastic / **Plastique** / Plastica

Ø	A	B	C	D	E	F
8	9.3	12.3	11.1	23.9	12.3	9
10	11.3	14.3	12.2	25.9	12.3	9
12	13.3	16.3	13.2	28	12.3	9
16	17.3	20.3	15.3	32.1	12.3	9
20	21.3	24.3	17.4	36.2	14	9
25	26.5	29.5	20	41.4	14	9