



ONE
hundred
percent
made in
ITALY

ROTATING CLEANING HEADS





OUR COMPANY

Cleaning containers and tools used in the production process is a costly task, but at the same time, a guarantee of high quality of the final product.

It is therefore imperative for any company to rely on a trustworthy and experienced partner, that may lead them to find the most suitable cleaning operations.

Wherever there is a container that needs to be cleaned, may it be a cement mixer, a tanker, or an industrial dough kneading machine, PA is present with a wide range of cleaning heads, developed during more than 30 years in the high pressure business. Since 1982, PA supplies accessories for high pressure cleaning. These include not only cleaning heads, but also a whole range of components for water at high pressure; basically, anything that is needed for high pressure plants, except for the pump.

Some of the fields where PA has been active for many years, gaining an enviable experience it can now share with its partners, are the food & beverage, chemical & pharmaceutical, oil & gas, transport, sewer cleaning, and bin cleaning industries.

PA, a market leader for the past 3 decades, is a company based on innovation and quality.

The dedicated technical staff support customers with dedication and expertise, on different fields and applications. The use of only the most advanced systems for designing and developing new products, in conformity to the main norms and regulations, such as ATEX and PED.

An advanced, certified quality system, that requires long-term testing before they hit the market, performed at the actual operational conditions.

A quick, efficient after-sale service, that can perform all scheduled and special maintenance to ensure the long life span of the heads.

All this is PA: your ideal partner for all tank cleaning necessity.

HIGH PRESSURE CLEANING Quality Efficiency Saving

Safety, productivity, confined space entry, dangerous cross contamination, are only some of the issues that arise from tank cleaning, whatever the dimension or the content.

In modern cleaning industry, there is no room for approximation.

On the one hand, the norms and regulations concerning safety, hygiene and safeguard of the environment are getting more and more stringent.

On the other, the need to reduce time and costs associated with the cleaning process are more and more urgent. All this imposes to walk away from manual cleaning, and to develop instead a cleaning process integrated into the production cycle.

The use of PA cleaning heads allows to respond to all these needs, by transforming what was before dead time in the production cycle, into an integral part of it, when the quality of the product is enhanced.

With PA cleaning heads, water jets follow a fixed pattern, that allows the whole surface of the container to be covered. Rotational speed is constant, independent from flow rate or temperature, even when the head is hydrokinetic, which means, driven by the water used for cleaning.

The time and water consumption needed in a single cleaning cycle are therefore known, and allow the operator to program the cleaning process in advance.

This makes it easier for the head to be assembled in Clean in Place systems, and improves the automation of the production cycle.

The operational range of PA heads, which varies between 30 and 140 bar (435 to 2030 PSI), allows for a variety of applications, thus making the difference between old cleaning habits, and modern, more efficient ways.

The water used in the cleaning process has a high impact on costs, both as a raw material, and as dirty water that needs to be reclaimed and/or disposed of.

A working pressure up to ten times higher than traditional cleaning heads allows – with same-size containers – for the same impact on the surface, but considerably reduced flow.

The high fluid-dynamic efficiency of PA heads and the optimal calibration of the rotational speed help decrease the nebulization of water jets, thus ensuring that they impact the surface at full energy.

The result is a powerful, trustworthy cleaning process, that can be repeated on every single point of the surface.

A highly efficient process, that, thanks to the reduced need for water, grants both quality and saving costs.

FIELDS OF APPLICATION

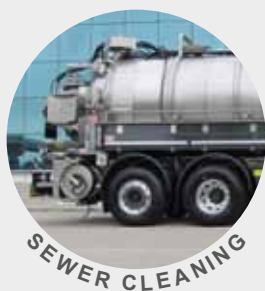

TOTAL COVERAGE 360°

HYDROKINETIC

A30R	pag. 8-9
A42R 360	pag. 8-9
A42R 360 AISI 316 ATEX	pag. 8-9
MI42 AISI 316 ATEX	pag. 8-9
MI63	pag. 8-9
MI63 ATEX	pag. 8-9
MI85	pag. 10-11
A80R	pag. 10-11
A80R2	pag. 10-11
A80R ATEX	pag. 10-11
A300R	pag. 10-11
TLR M4 AISI 316	pag. 10-11

ELECTRIC

M21E	pag. 12-13
M25E	pag. 12-13
M28E	pag. 12-13
M63E	pag. 14-15
M85E	pag. 14-15
TLR M4 AISI 316	pag. 14-15

PNEUMATIC

M63P ATEX	pag. 14-15
M85P ATEX	pag. 14-15
TLR M4 AISI 316	pag. 14-15

PARTIAL COVERAGE

HYDROKINETIC

A42R	pag. 16-17
A42R2	pag. 16-17
A42R AISI 316	pag. 16-17
A80RF	pag. 16-17



OUR ROTATING HEADS

- Each head is individually tested, and marked with a serial number.
- Each head has its own individual package, which includes technical manuals and maintenance booklets for reference.
- Regular maintenance helps increasing the life span of the head, and ensures that it stays in perfect shape.
- External nozzles are ordered and invoiced separately. The size is dictated by working pressure and flow rate. Selection charts to determine the right nozzles can be found on the PA web site.

HYDROKINETIC MODELS

- Each head is individually tested according to specifications of working pressure and flow rate.
- These heads suffer a pressure loss due to internal friction, which, depending on working flow, varies between 10 and 15 bar (145-215 PSI).
- 2 or 4 nozzles might be assembled, according to flow and the dimensions of the container.
- For a thorough cleaning process, it is advisable to work with min. 10 l/min (2.5 Gpm) for each nozzle.
- In case of orbital coverage, it is advised to use 4 nozzles in containers with a diameter of more than 3 m (9.8 ft).



**ADVANTAGES OF
WASHING WITH
ROTATING HEADS**

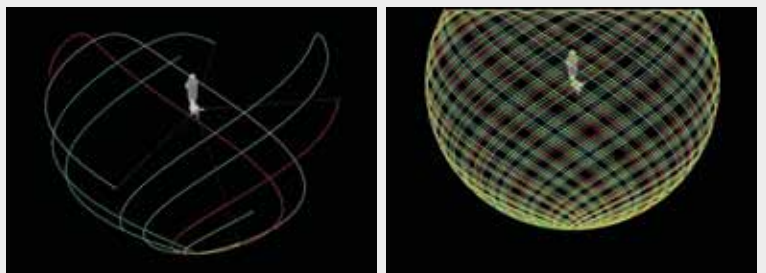

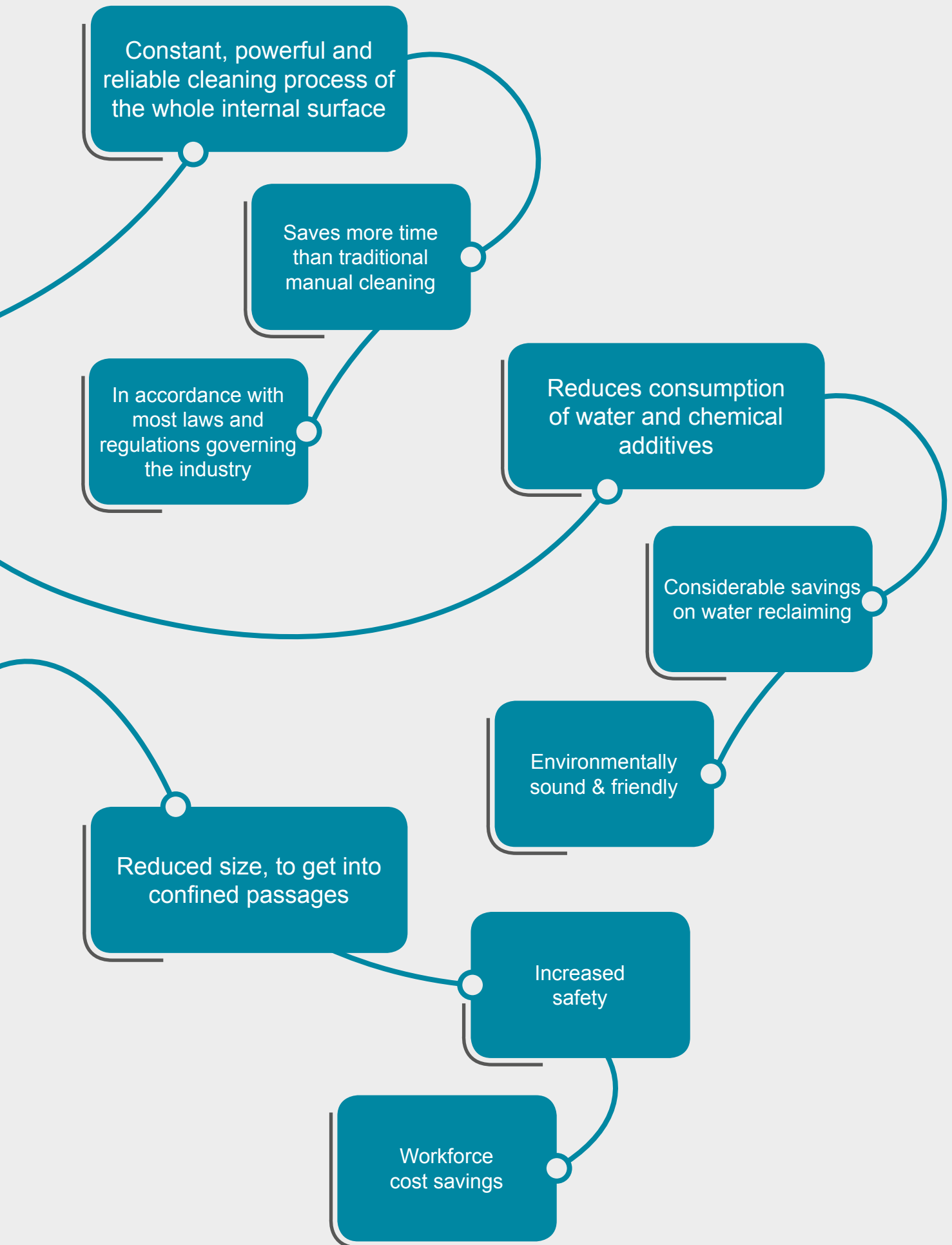

Comparative Chart



FOOD & BEVERAGE

WINERIES

BREWERIES

INDUSTRIAL

TOTAL COVERAGE 360°

HYDROKINETIC - With or without pipe



A30R

●

●

●



A42R 360

●

●

●



A42R 360
ATEX AISI 316

●



A80R

●



A80R
ATEX

●



A80R2

●



A300R

●



MI42 ATEX
AISI 316

●

●

●



MI63

●

●

●



MI63
ATEX

●



MI85

●

ELECTRIC



M21E

●

●

●



M25E

●

●



M28E

●

●



M63E

●

●

●



M85E

●

AIR DRIVEN



M63P
ATEX

●

●

●



M85P
ATEX

●

PARTIAL COVERAGE

HYDROKINETIC



A42R

●

●

●



A42R2

●

●

●



A42R ATEX
AISI 316

●

●

●



A80RF

●



CONSTRUCTION

OIL & GAS

CHEMICAL & PHARMA

COSMETICS

BIN CLEANING

SEWER CLEANING

TANKERS

●

●

●

●

●

●

●

●

●

●

●

●

●

●

●

●

●

●

●

●

●

●

●

●

●

●

●

●

●

●

●

●

●

●

●

●

●

●

●

●

●

●

●

●

●

●

●

●

●

●

●

●

●

●

●

●

●

●

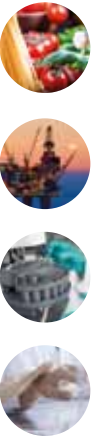
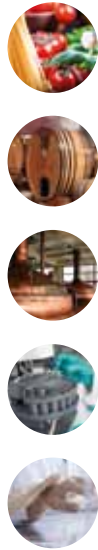

A30R

Ideal for lower flow, and confined entry. Made of Stainless Steel AISI 303.



A42R 360

Ideal for medium flow. Made of Stainless Steel AISI 303.



A42R 360 AISI 316 ATEX

deal for medium flow. Made of Stainless Steel AISI 316. Compliant with ATEX, FDA, NSF regulations. For use in food and pharma industries.

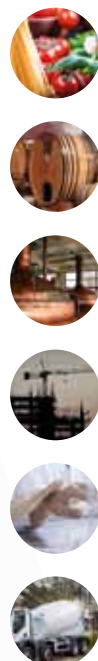
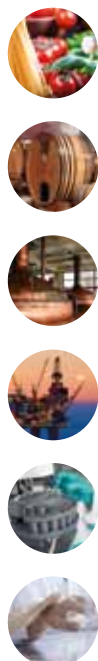

MI42 AISI 316 ATEX

For medium flow, the head is equipped with a pipe that allows for the nozzles to be inserted inside the container. Made of Stainless Steel AISI 316 and compliant with ATEX, FDA, NSF regulations. For use in food and pharma industries.



MI63

For medium flow, the head is equipped with a pipe that allows for the nozzles to be inserted inside the container. Made of Stainless Steel AISI 303.



MI63 ATEX

For medium flow, the head is equipped with a pipe that allows for the nozzles to be inserted inside the container. Made of Stainless Steel AISI 303. Compliant with ATEX certification.



WORKING PROCESS

The heads are self-rotating and volumetric, with rotational speed proportional to the inlet flow.

They clean the internal surface of containers and tanks, with complete orbital coverage, in a wide range of applications.

The cleaning cycle is completed with two rotations around the vertical axis: after the jets draw a hypothetical sphere once, they hit the same spots for a second time.

The rotation is caused by a hydrokinetic assembly, based on a turbine that is put in motion by three injectors on a planetary gear. The same water that pushes the rotation, then cleans in high pressure.

The rotational speed can be adjusted, within the span indicated on the booklet, by changing the size of the hole in the internal injectors – or injector disc, in different models. This speed is always directly proportional to the flow.

This system offers three main advantages:

- No oil or grease is necessary, since the speed is determined by the planetary gear. This avoids any risk of contamination in the cleaning process
- No oil or grease maintenance, and therefore, less maintenance in general
- Rotational speed is independent from water temperature, oil temperature, and the temperature in the surrounding environment.

SELECTION PROCESS

The main characteristics to take into account to select the right model are:

- Working pressure and flow rate
- Shape and dimensions of the container to clean
- Diameter of inlet hole
- Nature of dirt and/or substance to clean off
- Nature of detergent, or chemical additive in the water
- Allowed time to carry out a washing cycle

In case of aggressive chemical detergents, it is advisable to read our manuals beforehand to verify compatibility with inner seals.

A tank cleaning selection questionnaire is available on the PA web site. All customers are required to fill in all relevant data, to provide the PA staff with sufficient information to indicate the right head for the specific application. All hydrokinetic heads are pre-set, and tested according to given pressure and flow rate.

All hydrokinetic heads are equipped with:

- Internal injectors, in a size that reflects the working flow
- External nozzles, in a size that reflects both pressure and flow (please note: external nozzles are sold and invoiced separately)

MODEL	Inlet	Min/Max Flow	Max. Working Pressure	Min. Ø	Average Cycle Time	Nozzles Qty and Size	Body Material	Max. Working Temperature
A30R	1/2" Bsp F	10-30 l/min 2,6/8 USGpm	140 bar 2000 psi	60 mm	3'	2 o 4 x M4	Aisi 303	90°C - 195°F
A42R 360	1/2" Bsp F	13-55 l/min 3,4/14,5 USGpm	140 bar 2000 psi	130 mm	4'	2 o 4 x 1/8" M Npt	Aisi 303	90°C - 195°F
A42R 360 AISI 316 ATEX	1/2" Bsp F	13-55 l/min 3,4/14,5 USGpm	140 bar 2000 psi	130 mm	4'	2 o 4 x 1/8" M Npt	Aisi 316	90°C - 195°F
MI42 AISI 316 ATEX	1/2" Bsp F	13-55 l/min 3,4/14,5 USGpm	140 bar 2000 psi	63 mm	4'	2 o 4 x 1/8" M Npt	Aisi 316	90°C - 195°F
MI63 Min. inlet hole 45mm	3/4" Bsp F	13-55 l/min 3,4/14,5 USGpm	140 bar 2000 psi	45 mm	5'	2 o 4 x M4	Aisi 303	90°C - 195°F
MI63 Min. inlet hole 65mm	3/4" Bsp F	13-55 l/min 3,4/14,5 USGpm	140 bar 2000 psi	65 mm	5'	2 o 4 x 1/8" M Npt	Aisi 303	90°C - 195°F
MI63 ATEX	3/4" Bsp F	13-55 l/min 3,4/14,5 USGpm	140 bar 2000 psi	65 mm	5'	2 o 4 x 1/8" M Npt	Aisi 303	90°C - 195°F

EXTENSIONS

Extensions in different lengths are offered to match different containers' size on models Mi42 AISI 316 ATEX and MI63. Please note that the head needs to be positioned at the centre of the container.

ATEX VERSIONS (for applications in potentially explosive environments)

ATEX versions are offered for models A42R 360 AISI 316 ATEX, Mi42 AISI 316 ATEX and MI63 ATEX.

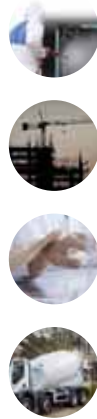

MI85

Ideal for larger flow, equipped with pipe to insert inside of the container. Made of Stainless Steel AISI 303.

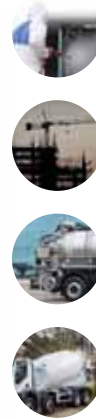

A80R

Ideal for larger flow. Made of Stainless Steel AISI 303.



A80R2

Ideal for larger flow, with high rotational speed. Made of Stainless Steel AISI 303.



A80R ATEX

Ideal for larger flow. Made of Stainless Steel AISI 303, with ATEX certification.

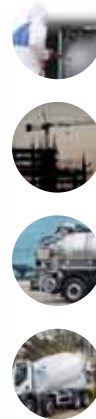

A300R

Ideal for larger flow at medium pressure. Made of Stainless Steel AISI 303. The longer reach of the nozzles allows to clean large containers.

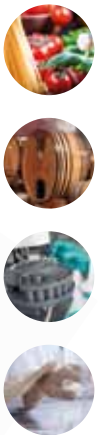

TLR M4 AISI 316

Small-sized tip with covered nozzles, that can be assembled on the M63 models, to be used in containers with reduced inlet holes.



WORKING PROCESS

The heads are self-rotating and volumetric, with rotational speed proportional to the inlet flow.

They clean the internal surface of containers and tanks, with complete orbital coverage, in a wide range of applications.

The cleaning cycle is completed with two rotations around the vertical axis: after the jets draw a hypothetical sphere once, they hit the same spots for a second time.

The rotation is caused by a hydrokinetic assembly, based on a turbine that is put in motion by three injectors on a planetary gear. The same water that pushes the rotation, then cleans in high pressure.

The rotational speed can be adjusted, within the span indicated on the booklet, by changing the size of the hole in the internal injectors – or injector disc, in different models. This speed is always directly proportional to the flow.

This system offers three main advantages:

- No oil or grease is necessary, since the speed is determined by the planetary gear. This avoids any risk of contamination in the cleaning process
- No oil or grease maintenance, and therefore, less maintenance in general
- Rotational speed is independent from water temperature, oil temperature, and the temperature in the surrounding environment.

SELECTION PROCESS

The main characteristics to take into account to select the right model are:

- Working pressure and flow rate
- Shape and dimensions of the container to clean
- Diameter of inlet hole
- Nature of dirt and/or substance to clean off
- Nature of detergent, or chemical additive in the water
- Allowed time to carry out a washing cycle

In case of aggressive chemical detergents, it is advisable to read our manuals beforehand to verify compatibility with inner seals.

A tank cleaning selection questionnaire is available on the PA web site. All customers are required to fill in all relevant data, to provide the PA staff with sufficient information to indicate the right head for the specific application. All hydrokinetic heads are pre-set, and tested according to given pressure and flow rate.

All hydrokinetic heads are equipped with:

- Internal injectors, in a size that reflects the working flow
- External nozzles, in a size that reflects both pressure and flow (please note: external nozzles are sold and invoiced separately)

MODEL	Inlet	Max. Working Pressure	Min/Max Flow	Min. Ø	Average Cycle Time	Nozzles Qty and Size	Body Material	Max. Working Temperature
MI85	3/4" Bsp F	140 bar 2000 psi	20-80 l/min 5.3/21 USGpm	86 mm	5'	2 o 4 x 1/4"M Npt*	Aisi 303	90°C - 195°F
A80R	3/4" Bsp F	140 bar 2000 psi	20-120 l/min 5.3/31.7 USGpm	137 mm	5'	2 o 4 x 1/4"M Npt*	Aisi 303	90°C - 195°F
A80R2	3/4" Bsp F	140 bar 2000 psi	20-120 l/min 5.3/31.7 USGpm	137 mm	1'	2 o 4 x 1/4"M Npt*	Aisi 303	90°C - 195°F
A80R ATEX	3/4" Bsp F	140 bar 2000 psi	20-120 l/min 5.3/31.7 USGpm	137 mm	5'	2 o 4 x 1/4"M Npt*	Aisi 303	90°C - 195°F
A300R	1" 1/4 Bsp F	140 bar 2000 psi	100-300 l/min 26.4/80 USGpm	160 mm	10'	2 o 4 x 1/4"M Npt*	Aisi 303	90°C - 195°F
TLR M4	-	140 bar 2000 psi	15-35 l/min 4-5.2 USGpm	40,5 mm	-	2 o 4 x M4	Aisi 316	90°C - 195°F

* EXTENDED NOZZLES

Extended nozzles are available for following models: MI85, A80R, A80R2, A80R ATEX, A300R and for sizes above 065. These nozzles grant a more compact water jet, with stronger impact on the surface.

EXTENSIONS

Extensions in different lengths are offered to match different containers' size on model MI85. Please note that the head needs to be positioned at the centre of the container.

ATEX VERSIONS (for applications in potentially explosive environments)

ATEX version is offered for model A80R.



M21 E

Electric-driven, ideal for small containers and barrels.



M25 E

Electric-driven, ideal for wooden barrels in the wine industry, with suction system to externally discharge washing residue.



M28 E

Elbow-shaped version of the M25 E, to be used in cramped working spaces. It is equipped with a flexible extension to suck off washing fluids.

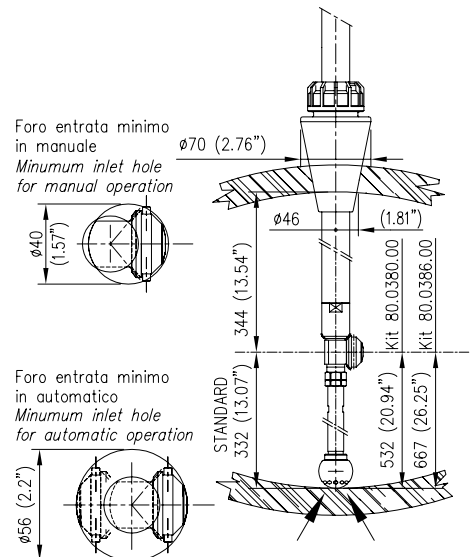
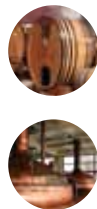

EXTENSIONS FOR LARGE BARRELS

These extensions allow to suck off washing fluids in large barrels.



WORKING PROCESS

The rotation of the heads is activated by an electric motor at the top.

They clean the internal surface of containers and tanks, with complete orbital coverage, in a wide range of applications.

The cleaning cycle is completed with two rotations around the vertical axis: after the jets draw a hypothetical sphere once, they hit the same spots for a second time.

The electric version offers three main advantages:

- Rotational speed is independent from flow: the rotation is steady even at low flow rates
- Pressure loss is minimal, thanks to a lack of throttles in the water line
- Easy maintenance

SELECTION PROCESS

The main characteristics to take into account to select the right model are:

- Working pressure and flow rate
- Shape and dimensions of the container to clean
- Diameter of inlet hole
- Nature of dirt and/or substance to clean off
- Nature of detergent, or chemical additive in the water
- Allowed time to carry out a washing cycle

In case of aggressive chemical detergents, it is advisable to read our manuals beforehand to verify compatibility with inner seals.

A tank cleaning selection questionnaire is available on the PA web site. All customers are required to fill in all relevant data, to provide the PA staff with sufficient information to indicate the right head for the specific application.

All electric heads are tested according to actual pressure and flow rate.

These heads are equipped with:

- External nozzles, in a size that reflects both pressure and flow (please note: external nozzles are sold and invoiced separately)
- Models M21 E, M25 E and M28 E are equipped with a full set of M4 nozzles.

MODEL	Inlet	Max. Working Pressure	Min/Max Flow	Min. Ø	Average Cycle Time	Nozzles Qty and Size	Body Material	Max. Working Temperature	Notes
M21 E	M22 M x 1,5	220 bar 3200 psi	10-21 l/min 2.6/5.5 USGpm	56 mm	2'	2 x M4	Aisi 303	90°C - 195°F	-
M25 E	M22 M x 1,5	140 bar 2000 psi	10-25 l/min 2.6/6.5 USGpm	56 mm	3'	2 x M4	Aisi 303	90°C - 195°F	Liquid suction
M28 E	M22 M x 1,5	140 bar 2000 psi	10-25 l/min 2.6/6.5 USGpm	56 mm	3'	2 x M4	Aisi 303	90°C - 195°F	Liquid suction

EXTENSIONS	A	B max.
STANDARD Heads	ø46	ø730
Heads + KIT 80.0380.00	ø50	ø940
Heads + KIT 80.0386.00	ø50	ø1070

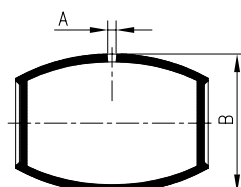

ELECTRIC-DRIVEN HEADS

Models M21 E, M25 E and M28 E can be supplied with different electric plugs, in accordance with power outlets around the world.

EXTENSIONS

Extensions in different lengths are offered to match different containers' size on model MI85.

Please note that the head needs to be positioned at the centre of the container.

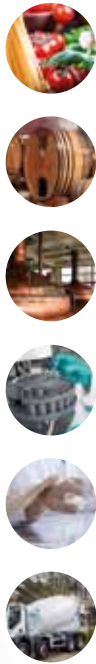

M63E

Ideal for medium flow, the head is equipped with a pipe to insert the nozzles inside the container. Made of Stainless Steel AISI 303.



M63P ATEX

Ideal for medium flow, the head is equipped with a pipe to insert the nozzles inside the container. Made of Stainless Steel AISI 303, with ATEX certification.

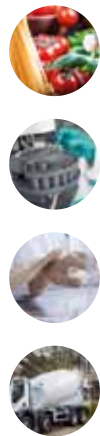

M85E

Ideal for large flow, the head is equipped with a pipe to insert the nozzles inside the container. Made of Stainless Steel AISI 303.



M85P ATEX

Ideal for large flow, the head is equipped with a pipe to insert the nozzles inside the container. Made of Stainless Steel AISI 303, with ATEX certification.

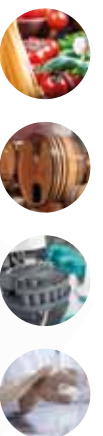

TLR M4 AISI 316

Small-sized tip with covered nozzles, that can be assembled on the M63 models, to be used in containers with reduced inlet holes.



WORKING PROCESS

The rotation of the heads is activated by an electric motor at the top. They clean the internal surface of containers and tanks, with complete orbital coverage, in a wide range of applications. The cleaning cycle is completed with two rotations around the vertical axis: after the jets draw a hypothetical sphere once, they hit the same spots for a second time.

The electric version offers three main advantages:

- Rotational speed is independent from flow: the rotation is steady even at low flow rates
- Pressure loss is minimal, thanks to a lack of throttles in the water line
- Easy maintenance

SELECTION PROCESS

The main characteristics to take into account to select the right model are:

- Working pressure and flow rate
- Shape and dimensions of the container to clean
- Diameter of inlet hole
- Nature of dirt and/or substance to clean off
- Nature of detergent, or chemical additive in the water
- Allowed time to carry out a washing cycle

In case of aggressive chemical detergents, it is advisable to read our manuals beforehand to verify compatibility with inner seals.

A tank cleaning selection questionnaire is available on the PA web site. All customers are required to fill in all relevant data, to provide the PA staff with sufficient information to indicate the right head for the specific application.

All electric heads are tested according to actual pressure and flow rate.

These heads are equipped with:

- External nozzles, in a size that reflects both pressure and flow (please note: external nozzles are sold and invoiced separately)

MODEL	Inlet	Max. Working Pressure	Min/Max Flow	Air consumption	Min. Ø	Average Cycle Time	Nozzles Qty and Size	Body Material	Max. Working Temperature
M63E Min. inlet hole 45mm	3/8" Bsp F	140 bar 2000 psi	13-55 l/min 3.4/14.5 USGpm	-	45 mm	6'	2 o 4 x M4	Aisi 303	90°C - 195°F
M63E Min. inlet hole 65mm	3/8" Bsp F	140 bar 2000 psi	13-55 l/min 3.4/14.5 USGpm	-	65 mm	6'	2 o 4 x 1/8" Npt	Aisi 303	90°C - 195°F
M63P ATEX Min. inlet hole 45mm	3/8" Bsp F	140 bar 2000 psi	13-55 l/min 3.4/14.5 USGpm	3.8 l/sec 3 bar	45 mm	6'	2 o 4 x M4	Aisi 303	90°C - 195°F
M63P ATEX Min. inlet hole 65mm	3/8" Bsp F	140 bar 2000 psi	13-55 l/min 3.4/14.5 USGpm	3.8 l/sec 3 bar	65 mm	6'	2 o 4 x 1/8" Npt	Aisi 303	90°C - 195°F
M85E	3/8" Bsp F	140 bar 2000 psi	20-80 l/min 5.3/21 USGpm	-	86 mm	6'	2 o 4 x 1/4" Npt*	Aisi 303	90°C - 195°F
M85P ATEX	3/8" Bsp F	140 bar 2000 psi	20-80 l/min 5.3/21 USGpm	3.8 l/sec 3 bar	86 mm	6'	2 o 4 x 1/4" Npt*	Aisi 303	90°C - 195°F
TLR M4	-	140 bar 2000 psi	15-35 l/min 4/9.2 USGpm	-	40,5 mm	-	2 o 4 x M4	Aisi 316	90°C - 195°F

* EXTENDED NOZZLES

Extended nozzles are available for following models: M85E, M85P ATEX and for sizes above 065. These nozzles grant a more compact water jet, with stronger impact on the surface.

EXTENSIONS

Extensions in different lengths are offered to match different containers' size on models M63 and M85. Please note that the head needs to be positioned at the centre of the container.



PARTIAL COVERAGE

HYDROKINETIC

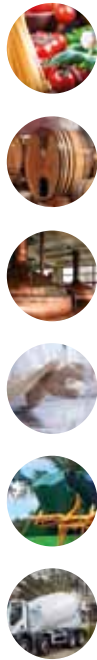

A42R

Ideal for medium flow. Made of Stainless Steel AISI 303.

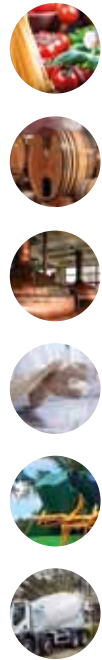

A42R2

Ideal for medium flow at higher speed. Made of Stainless Steel AISI 303.

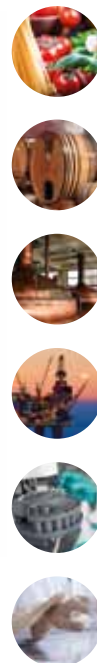

A42R AISI 316

Ideal for medium flow. Made of Stainless Steel Aisi 316. Compliant with ATEX, FDA, NSF regulations. For use in food and pharma industries.

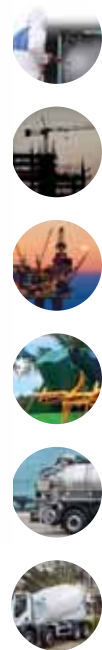

A80RF

Ideal for larger flow. Made of Stainless Steel AISI 303.



WORKING PROCESS

The heads are self-rotating and volumetric, with rotational speed proportional to the inlet flow.

They clean the internal surface of open-top containers and tanks, with partial coverage, in a wide range of applications.

The cleaning cycle is completed with two rotations around the vertical axis: the jets cover a section of 244° of the internal surface of the container.

The rotation is caused by a hydrokinetic assembly, based on a turbine that is put in motion by three injectors on a planetary gear. The same water that pushes the rotation, then cleans in high pressure.

The rotational speed can be adjusted, within the span indicated on the booklet, by changing the size of the hole in the internal injectors – or injector disc, in different models. This speed is always directly proportional to the flow.

The partial coverage system offers two main advantages:

- No lid necessary when washing open-top containers
- It saves water: when placing the head at the centre of the container, only the sides and the bottom are washed

SELECTION PROCESS

The main characteristics to take into account to select the right model are:

- Working pressure and flow rate
- Shape and dimensions of the container to clean
- Diameter of inlet hole
- Nature of dirt and/or substance to clean off
- Nature of detergent, or chemical additive in the water
- Allowed time to carry out a washing cycle

In case of aggressive chemical detergents, it is advisable to read our manuals beforehand to verify compatibility with inner seals.

A tank cleaning selection questionnaire is available on the PA web site. All customers are required to fill in all relevant data, to provide the PA staff with sufficient information to indicate the right head for the specific application. All hydrokinetic heads are pre-set, and tested according to given pressure and flow rate.

All hydrokinetic heads are equipped with:

- Internal injectors, in a size that reflects the working flow
- External nozzles, in a size that reflects both pressure and flow (please note: external nozzles are sold and invoiced separately)

MODEL	Inlet	Max. Working Pressure	Min/Max Flow	Average Cycle Time	Nozzles Qty and Size	Body Material	Max. Working Temperature
A42R	1/2" Bsp F	140 bar 2000 psi	20-50 l/min 5.3/13.2 USGpm	1' 30"	3 x 1/8"M Npt*	Aisi 303	90°C - 195°F
A42R2	1/2" Bsp F	140 bar 2000 psi	20-50 l/min 5.3/13.2 USGpm	30"	3 x 1/8"M Npt*	Aisi 303	90°C - 195°F
A42R AISI 316	1/2" Bsp F	140 bar 2000 psi	20-55 l/min 5.3/14.5 USGpm	1' 30"	3 x 1/8"M Npt*	Aisi 316	90°C - 195°F
A80RF	3/4" Bsp F	140 bar 2000 psi	20-120 l/min 5.3/31.7 USGpm	5'	2 o 4 x 1/4"M Npt*	Aisi 303	90°C - 195°F

* EXTENDED NOZZLES

Extended nozzles are available for following models: A42R, A42R2, A42R AISI 316, A80RF and for sizes above 065. These nozzles grant a more compact water jet, with stronger impact on the surface.



EXTERNAL SURFACE CLEANING

The range of products for surface cleaning includes self-rotating models, that run on the same mechanical water-driven groups used in rotating heads. This design is based on the work of calibrated injectors, in combination with a turbine and a planetary gear, and it allows a tight control over rotational speed. The whole cleaning process is therefore controllable, and can be replicated to reduce both time and cost.

The rotational speed is usually around 50-260 rpm, much lower when compared to the radial, turbine-less swivel activated by the push reaction of the water. Water jets are therefore more powerful, because water does not atomize. Thanks to the elevated impact of these jets, the cleaning action is efficient even when nozzles are at a distance of 1 m from the surface.



Comparative chart







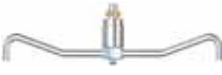

CARWASH

TANKERS

RAILWAY SECTOR

CONVEYORS

		EXTERNAL SURFACE CLEANING			
		CARWASH	TANKERS	RAILWAY SECTOR	CONVEYORS
RADIAL	 GR38	●	●	●	●
	 GR38 200/400	●	●	●	●
	 A80FR2		●	●	●
DIRECTIONAL	 A42FR2	●	●	●	●
	 A42FR2 45	●	●	●	●
	 A43FR2	●	●	●	●
	 A44FR2	●	●	●	●

FIELDS OF APPLICATION



CARWASH



TANKERS



RAILWAY SECTOR



CONVEYORS

EXTERNAL SURFACE CLEANING

RADIAL

GR38	pag. 20-21
GR38 200/400	pag. 20-21
A80FR2	pag. 21

DIRECTIONAL

A42FR2	pag. 20-21
A42FR2 45	pag. 20-21
A43FR2	pag. 20-21
A44FR2	pag. 20-21

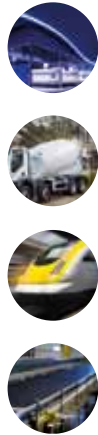

GR38

Self-rotating, water-driven swivel.

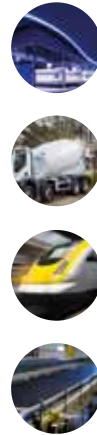

GR38 200-400

Self-rotating, water-driven swivel, with arms of variable length.

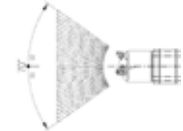
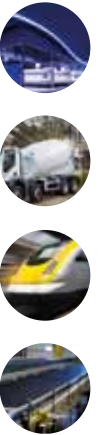

A42FR2

Cleaning head, with three nozzles on the same 70° angle.

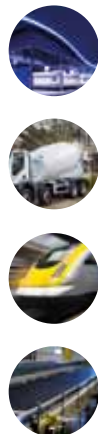

A42FR2 45

Cleaning head, with three nozzles on the same 45° angle.

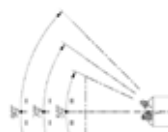
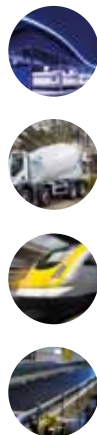

A43FR2

Cleaning head, with three nozzles on 3 different angles: 50° - 70° - 90°.

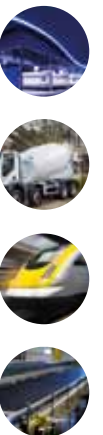

A44FR2

Cleaning head, with four nozzles on 4 different angles: 46° - 60° - 76° - 90°.



WORKING PROCESS

Hydrokinetic, self-rotating heads, propelled by the water used for cleaning.

In this circuit, water in high pressure flows through the calibrated injectors and hits a turbine, which propagates the rotation around the main axis through a planetary gear.

Rotational speed is regulated through calibrated injectors, according to the working flow rate.



A80FR2

Rotating head for larger flow, covering a diameter 800mm (2.6 ft) wide.

SELECTION PROCESS

The main characteristics to take into account to select the right model are:

- Working pressure and flow rate
- Diameter of inlet hole
- Nature of dirt and/or substance to clean off
- Nature of detergent, or chemical additive in the water
- Allowed time to carry out a washing cycle

In case of aggressive chemical detergents, it is advisable to read our manuals beforehand to verify compatibility with inner seals.

A tank cleaning selection questionnaire is available on the PA web site. All customers are required to fill in all relevant data, to provide the PA staff with sufficient information to indicate the right head for the specific application.

All hydrokinetic heads are pre-set, and tested according to given pressure and flow rate.

All hydrokinetic heads are equipped with:

- Internal injectors, in a size that reflects the working flow
- External nozzles, in a size that reflects both pressure and flow (please note: external nozzles are sold and invoiced separately)

MODEL	Inlet	Max. Working Pressure	Min/Max Flow	Rpm/min	Nozzles Qty and Size	Body Material	Max. Working Temperature
GR38	3/8" Bsp M	350 bar 5100 psi	0-40 l/min 0/10.5 USGpm	0-2000	2 o 3 x 1/8" M Npt	Aisi 303	90°C - 195°F
GR38 200-400	3/8" Bsp M	350 bar 5100 psi	0-40 l/min 0/10.5 USGpm	750-1000	2 o 3 x 1/8" M Npt	Aisi 303	90°C - 195°F
A42FR2	1/2" Bsp F	140 bar 2000 psi	20-60 l/min 5.3/16 USGpm	180-260	3 x 1/4" M Npt*	Aisi 303	90°C - 195°F
A42FR2 45	1/2" Bsp F	140 bar 2000 psi	20-60 l/min 5.3/16 USGpm	180-260	3 x 1/4" M Npt*	Aisi 303	90°C - 195°F
A43FR2	1/2" Bsp F	140 bar 2000 psi	20-60 l/min 5.3/16 USGpm	180-260	3 x 1/4" M Npt*	Aisi 303	90°C - 195°F
A44FR2	1/2" Bsp F	140 bar 2000 psi	20-60 l/min 5.3/16 USGpm	180-260	4 x 1/4" M Npt*	Aisi 303	90°C - 195°F
A80FR2	3/4" Bsp F	140 bar 2000 psi	20-80 l/min 5.3/21 USGpm	50-150	2 x 1/4" M Npt*	Aisi 303	90°C - 195°F

* EXTENDED NOZZLES

Extended nozzles are available for following models: A42FR2, A42FR2 45, A43FR2, A44FR2, and for sizes above 065. These nozzles grant a more compact water jet, with stronger impact on the surface.



P.A. S.p.A.
Via Milano, 13
42048 Rubiera, Reggio Emilia - Italy

Tel +39.0522.623611
Fax +39.0522.629600

info@pa-etl.it

www.pa-etl.it

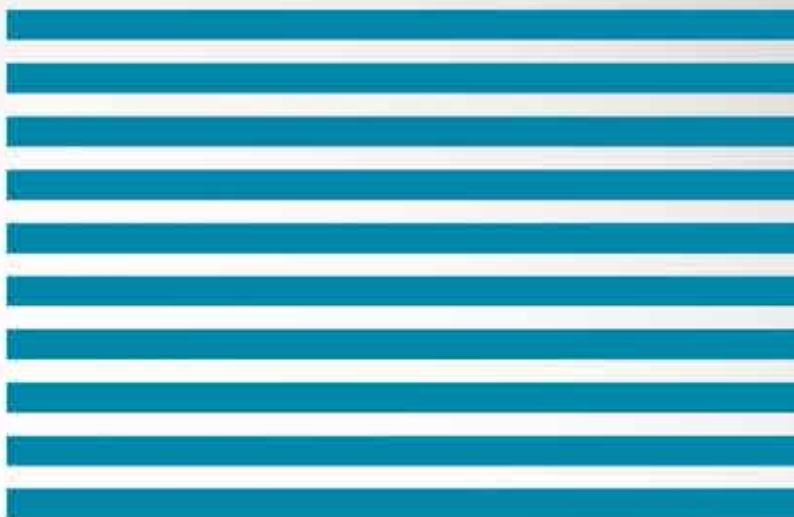

COMPANY WITH QUALITY MANAGEMENT
SYSTEM CERTIFIED BY DNV
= ISO 9001 =

RESELLER - DEALER :

Empty rounded rectangular box for reseller/dealer information.