



Series 200

General

The series 200 consist of a broad range of valves with various type of actuation.

The connections for this series are from G 1/8" to G 1".

Due to their special construction with a balanced spool, these valves can be used interchangeably as 3 ways or 5 ways.

The 3 ways can be used normally closed or normally open and the 5 ways can be fed through the exhausts 3 and 5 with different pressures according to the need.

The spool, as it is moving, isolates the connections without being affected by the inlet pressure.

Construction characteristics

	G 1/8" - G 1/4" - G 1/2" - G 1"
Body	Aluminium
Operators	Aluminium Technopolymer
Seals	NBR PUR for 212/2
Spacer	Technopolymer Aluminium for G1" (211)
Spools	Steel Aluminium, for 212/2
Springs	Spring steel
Pistons	Technopolymer, for 228 pneumatic command valves Aluminium, for 224, 212, 212/2 e 211 pneumatic command valves

Use and maintenance

This valves have an average life of 15 million cycles depending on the application and air quality.

Filtered and lubricated air using specified lubricants will reduce the wear of the seals and ensures long and trouble free operation.

Please ensure that the valve is being used according with the manufacturers specification, such as air pressure and temperature.

The exhaust port of the distributor has to be protected in a dusty and dirty environment.

Repair kits including the spool complete with seals are available for overhauling the valves.

However, although this is a simple operation it should be carried out by a competent person.

ATTENTION: use hydraulic oil class H for lubrication such as MAGNA GC 32 (Castrol).



AIR DISTRIBUTION 1

Tappet - Spring

Coding: 228. **T**.0.1

Operational characteristics	
Fluid	Filtered air. No lubrication needed, if applied it shall be continuous
Max working pressure (bar)	10
Temperature °C	-5 ÷ +70
Flow rate at 6 bar with Δp=1 (NI/min)	540
Orifice size (mm)	6
Working ports size	G1/8"

TYPE	
T	32 = 3 ways
	52 = 5 ways

3 ways

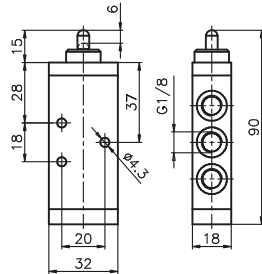

Weight 85 g
Operating force 33 N

228.32.0.1

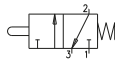

5 ways

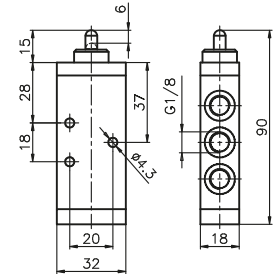

Weight 105 g
Operating force 33 N

228.52.0.1



Tappet panel - Spring

Coding: 228. **T**.1.1

Operational characteristics	
Fluid	Filtered air. No lubrication needed, if applied it shall be continuous
Max working pressure (bar)	10
Temperature °C	-5 ÷ +70
Flow rate at 6 bar with Δp=1 (NI/min)	540
Orifice size (mm)	6
Working ports size	G1/8"

TYPE	
T	32 = 3 ways
	52 = 5 ways

3 ways

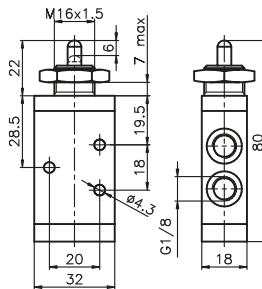

Weight 102 g
Operating force 33 N

228.32.1.1

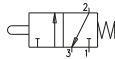

5 ways

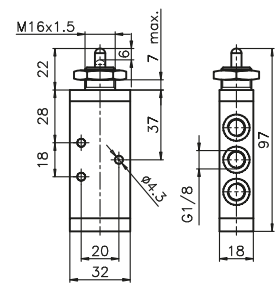

Weight 122 g
Operating force 33 N

228.52.1.1



Lever roller - Spring

Coding: 228. **T**.2. **V**

Operational characteristics	
Fluid	Filtered air. No lubrication needed, if applied it shall be continuous
Max working pressure (bar)	10
Temperature °C	-5 ÷ +70
Flow rate at 6 bar with Δp=1 (NI/min)	540
Orifice size (mm)	6
Working ports size	G1/8"

TYPE	
T	32 = 3 ways
	52 = 5 ways

VERSION	
V	1 = Plastic roller
	1/2 = Metal roller

3 ways

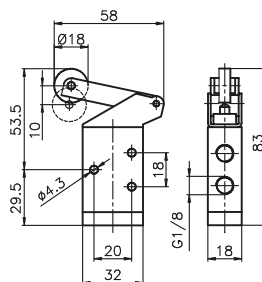

Weight 115 g
Operating force 15 N

228.32.2. **V**

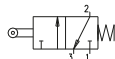

5 ways

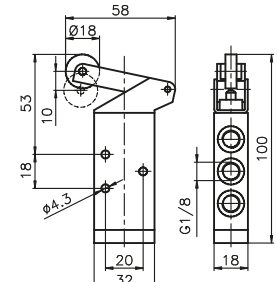

Weight 135 g
Operating force 15 N

228.52.2. **V**

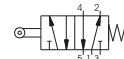

Lever roller unidirectional - Spring

Coding: 228.●.3.●

Operational characteristics

Fluid	Filtered air. No lubrication needed, if applied it shall be continuous
Max working pressure (bar)	10
Temperature °C	-5 ÷ +70
Flow rate at 6 bar with Δp=1 (NI/min)	540
Orifice size (mm)	6
Working ports size	G1/8"

TYPE	
●	32 = 3 ways
	52 = 5 ways
VERSION	
●	1 = Plastic roller
	1/2 = Metal roller

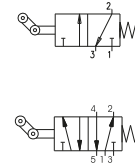

AIR DISTRIBUTION

3 ways

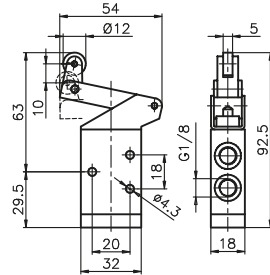

Weight 110 g

228.32.3.●

5 ways

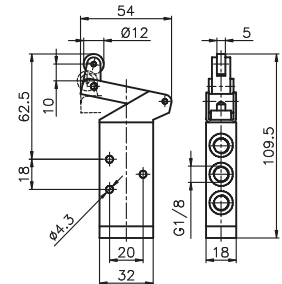

Weight 130 g

228.52.3.●

Lever roller lateral bidirectional - Spring

Coding: 228.●.4.1

Operational characteristics

Fluid	Filtered air. No lubrication needed, if applied it shall be continuous
Max working pressure (bar)	10
Temperature °C	-5 ÷ +70
Flow rate at 6 bar with Δp=1 (NI/min)	540
Orifice size (mm)	6
Working ports size	G1/8"

TYPE	
●	32 = 3 ways
	52 = 5 ways

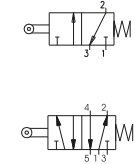

3 ways

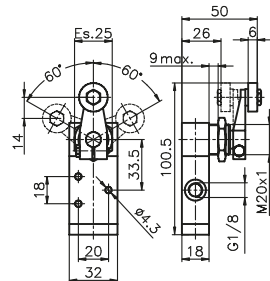

Weight 180 g

228.32.4.1

5 ways

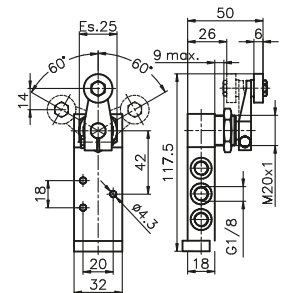

Weight 200 g

228.52.4.1

Lever sensitive - differential

Coding: 228.●.4.13

Operational characteristics

Fluid	Filtered air. No lubrication needed, if applied it shall be continuous
Max working pressure (bar)	10
Temperature °C	-5 ÷ +70
Flow rate at 6 bar with Δp=1 (NI/min)	540
Orifice size (mm)	6
Working ports size	G1/8"

TYPE	
●	32 = 3 ways
	52 = 5 ways

Minimum rotation angle 11°

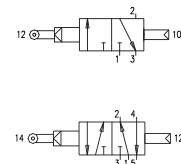

3 ways

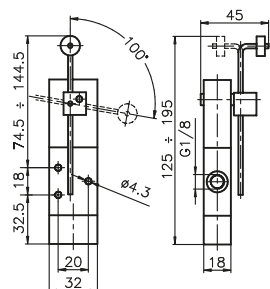

Weight 200 g

Minimum rotation angle 11°

Minimum working pressure 2,5 bar

228.32.4.13

5 ways

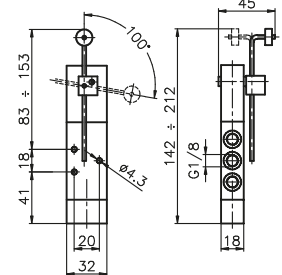

Weight 220 g

Minimum rotation angle 11°

Minimum working pressure 2,5 bar

228.52.4.13

Lever panel Ø30 - 2 positions

Coding: 228.1.5/C

Operational characteristics	
Fluid	Filtered air. No lubrication needed, if applied it shall be continuous
Max working pressure (bar)	10
Temperature °C	-5 ÷ +70
Flow rate at 6 bar with Δp=1 (NI/min)	540
Orifice size (mm)	6
Working ports size	G1/8"

T	TYPE
	32 = 3 ways 52 = 5 ways
C	LEVER COLOR
	1 = Red 2 = Black 3 = Green

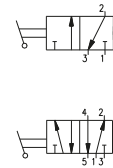

3 ways



Weight 198 g

228.32.5/C

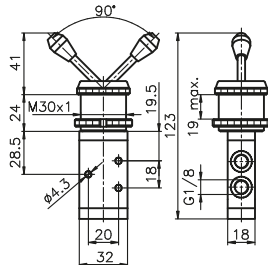

5 ways



Weight 218 g

228.52.5/C

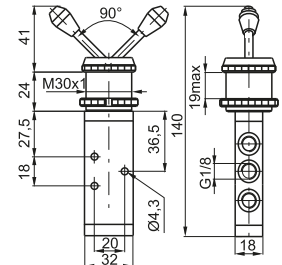

Frontal lever - 2 positions

Coding: 228.1.55/C

Operational characteristics	
Fluid	Filtered air. No lubrication needed, if applied it shall be continuous
Max working pressure (bar)	10
Temperature °C	-5 ÷ +70
Flow rate at 6 bar with Δp=1 (NI/min)	540
Orifice size (mm)	6
Working ports size	G1/8"

T	TYPE
	32 = 3 ways 52 = 5 ways
C	LEVER COLOR
	1 = Red 2 = Black 3 = Green

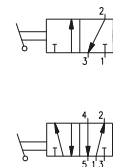

3 ways



Weight 115 g

228.32.55/C

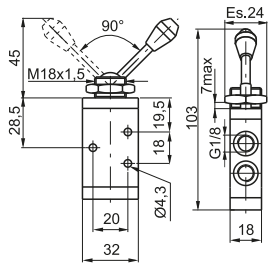

5 ways



Weight 135 g

228.52.55/C

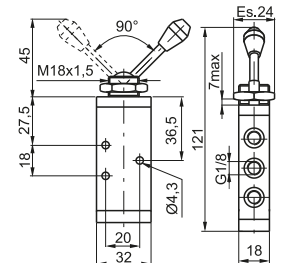

Push button Ø 30 - spring

Coding: 228.1.6.1/C

Operational characteristics	
Fluid	Filtered air. No lubrication needed, if applied it shall be continuous
Max working pressure (bar)	10
Temperature °C	-5 ÷ +70
Flow rate at 6 bar with Δp=1 (NI/min)	540
Orifice size (mm)	6
Working ports size	G1/8"

T	TYPE
	32 = 3 ways 52 = 5 ways
C	BUTTON COLOR
	1 = Red 2 = Black 3 = Green

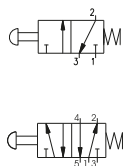

3 ways



Weight 155 g
Operating force 33 N

228.32.6.1/C

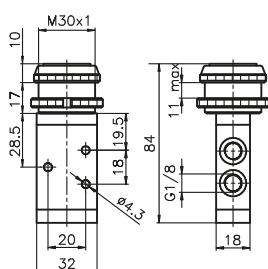

5 ways



Weight 175 g
Operating force 33 N

228.52.6.1/C

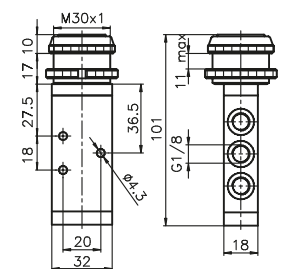

Sensitive push button Ø30 - differential

Coding: 228.1.6.13/C

Operational characteristics

Fluid	Filtered air. No lubrication needed, if applied it shall be continuous
Max working pressure (bar)	10
Temperature °C	-5 ÷ +70
Flow rate at 6 bar with Δp=1 (NI/min)	540
Orifice size (mm)	6
Working ports size	G1/8"

TYPE	32 = 3 ways 52 = 5 ways
BUTTON COLOR	1 = Red 2 = Black 3 = Green

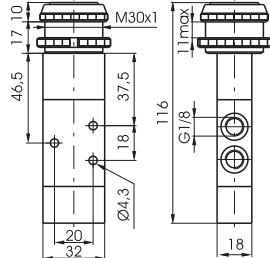
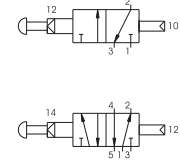

Weight 197 g
Operating force 18,5 N (at 6 bar)

228.32.6.13/C

5 ways

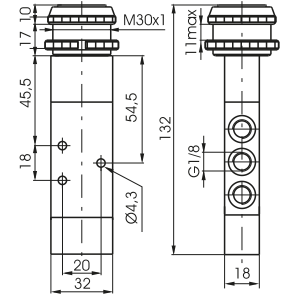

Weight 217 g
Operating force 18,5 N (at 6 bar)

228.52.6.13/C

Push button - Spring

Coding: 228.1.6.22/C

Operational characteristics

Fluid	Filtered air. No lubrication needed, if applied it shall be continuous
Max working pressure (bar)	10
Temperature °C	-5 ÷ +70
Flow rate at 6 bar with Δp=1 (NI/min)	540
Orifice size (mm)	6
Working ports size	G1/8"

TYPE	32 = 3 ways 52 = 5 ways
BUTTON COLOR	1 = Red 2 = Black 3 = Green 4 = Yellow

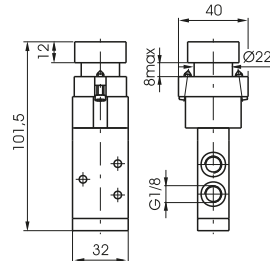
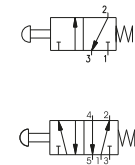

Weight 225 g
Operating force 33 N

228.32.6.22/C

5 ways

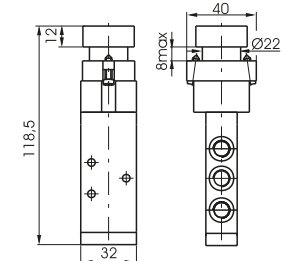

Weight 245 g
Operating force 33 N

228.52.6.22/C

Raised push button Ø22 - Spring

Coding: 228.1.6.23/C

Operational characteristics

Fluid	Filtered air. No lubrication needed, if applied it shall be continuous
Max working pressure (bar)	10
Temperature °C	-5 ÷ +70
Flow rate at 6 bar with Δp=1 (NI/min)	540
Orifice size (mm)	6
Working ports size	G1/8"

TYPE	32 = 3 ways 52 = 5 ways
BUTTON COLOR	1 = Red 2 = Black 3 = Green 4 = Yellow

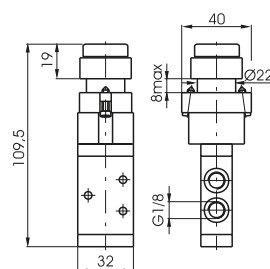
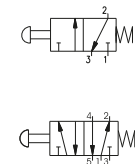

Weight 230 g
Operating force 33 N

228.32.6.23/C

5 ways

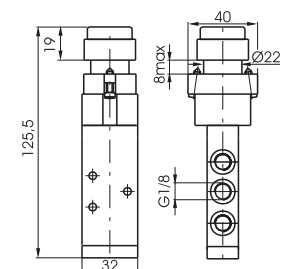

Weight 250 g
Operating force 33 N

228.52.6.23/C

AIR DISTRIBUTION

1

Push button Ø22 - 2 positions

Coding: 228.1.6.25

Operational characteristics	
Fluid	Filtered air. No lubrication needed, if applied it shall be continuous
Max working pressure (bar)	10
Temperature °C	-5 ÷ +70
Flow rate at 6 bar with Δp=1 (NI/min)	540
Orifice size (mm)	6
Working ports size	G1/8"

TYPE	
32	= 3 ways
52	= 5 ways

Emergency - Rotate to unlock

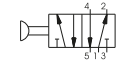
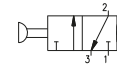

3 ways



Weight 235 g
Operating force 33 N

228.32.6.25

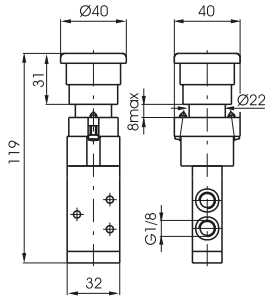

5 ways



Weight 235 g
Operating force 33 N

228.52.6.25

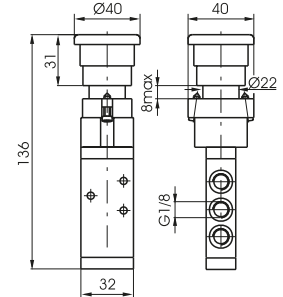

Switch 2 positions

Coding: 228.1.6.27

Operational characteristics	
Fluid	Filtered air. No lubrication needed, if applied it shall be continuous
Max working pressure (bar)	10
Temperature °C	-5 ÷ +70
Flow rate at 6 bar with Δp=1 (NI/min)	540
Orifice size (mm)	6
Working ports size	G1/8"

TYPE	
32	= 3 ways
52	= 5 ways

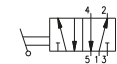
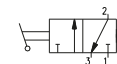

3 ways



Weight 230 g

228.32.6.27

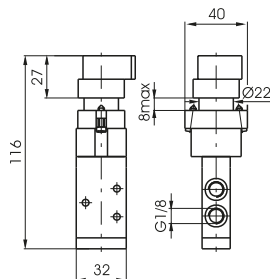

5 ways



Weight 250 g

228.52.6.27

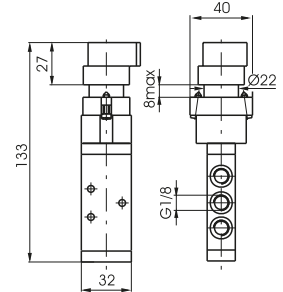

Key switch 2 positions

Coding: 228.1.6.28

Operational characteristics	
Fluid	Filtered air. No lubrication needed, if applied it shall be continuous
Max working pressure (bar)	10
Temperature °C	-5 ÷ +70
Flow rate at 6 bar with Δp=1 (NI/min)	540
Orifice size (mm)	6
Working ports size	G1/8"

TYPE	
32	= 3 ways
52	= 5 ways

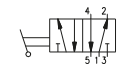
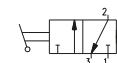

3 ways



Weight 230 g

228.32.6.28

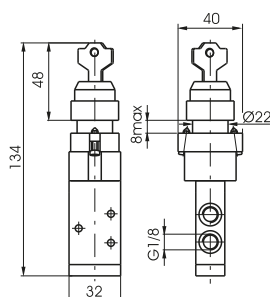

5 ways



Weight 250 g

228.52.6.28

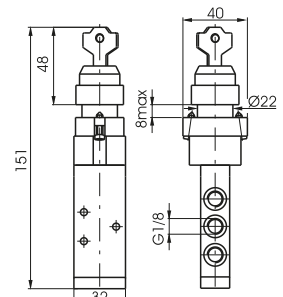



1 AIR DISTRIBUTION

Palm push button Ø30 2 positions

Coding: 228.1.7.1/C

Operational characteristics	
Fluid	Filtered air. No lubrication needed, if applied it shall be continuous
Max working pressure (bar)	10
Temperature °C	-5 ÷ +70
Flow rate at 6 bar with Δp=1 (NI/min)	540
Orifice size (mm)	6
Working ports size	G1/8"

TYPE	32 = 3 ways 52 = 5 ways
BUTTON COLOR	1 = Red 2 = Black 3 = Green

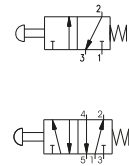

3 ways

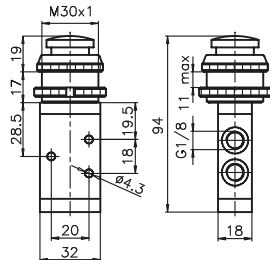

Weight 148 g

228.32.7.1/C

5 ways

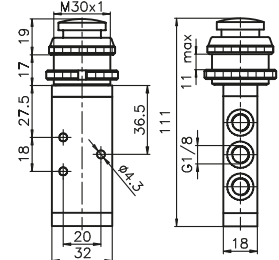

Weight 168 g

228.52.7.1/C

Push button - Spring

Coding: 228.1.8.1/C

Operational characteristics	
Fluid	Filtered air. No lubrication needed, if applied it shall be continuous
Max working pressure (bar)	10
Temperature °C	-5 ÷ +70
Flow rate at 6 bar with Δp=1 (NI/min)	540
Orifice size (mm)	6
Working ports size	G1/8"

TYPE	32 = 3 ways 52 = 5 ways
BUTTON COLOR	1 = Red 2 = Black 3 = Green

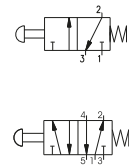

3 ways

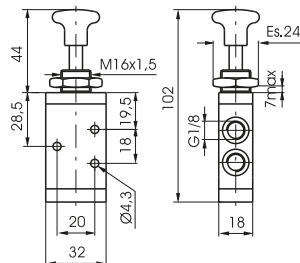

Weight 120 g

228.32.8.1/C

5 ways

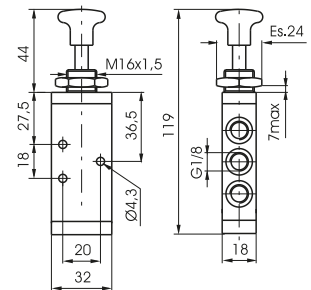

Weight 140 g

228.52.8.1/C

Push button 2 positions

Coding: 228.1.8/C

Operational characteristics	
Fluid	Filtered air. No lubrication needed, if applied it shall be continuous
Max working pressure (bar)	10
Temperature °C	-5 ÷ +70
Flow rate at 6 bar with Δp=1 (NI/min)	540
Orifice size (mm)	6
Working ports size	G1/8"

TYPE	32 = 3 ways 52 = 5 ways
BUTTON COLOR	1 = Red 2 = Black 3 = Green

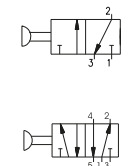

3 ways

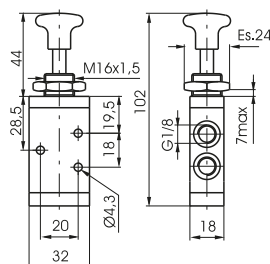

Weight 120 g

228.32.8/C

5 ways

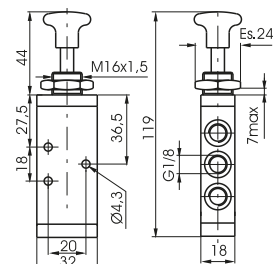

Weight 140 g

228.52.8/C

Lever lateral - Spring

Coding: 228.1.9.1/C

Operational characteristics	
Fluid	Filtered air. No lubrication needed, if applied it shall be continuous
Max working pressure (bar)	10
Temperature °C	-5 ÷ +70
Flow rate at 6 bar with $\Delta p=1$ (NI/min)	540
Orifice size (mm)	6
Working ports size	G1/8"

T	TYPE
	32 = 3 ways 52 = 5 ways
C	LEVER COLOR
	1 = Red
	2 = Black 3 = Green

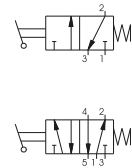

3 ways



Weight 140 g

228.32.9.1/C

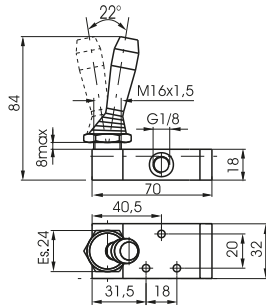

5 ways



Weight 160 g

228.52.9.1/C

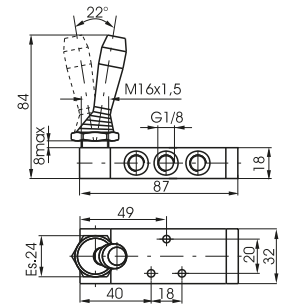

Lever lateral 2 positions

Coding: 228.1.9/C

Operational characteristics	
Fluid	Filtered air. No lubrication needed, if applied it shall be continuous
Max working pressure (bar)	10
Temperature °C	-5 ÷ +70
Flow rate at 6 bar with $\Delta p=1$ (NI/min)	540
Orifice size (mm)	6
Working ports size	G1/8"

T	TYPE
	32 = 3 ways 52 = 5 ways
C	LEVER COLOR
	1 = Red
	2 = Black 3 = Green

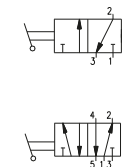

3 ways



Weight 140 g

228.32.9/C

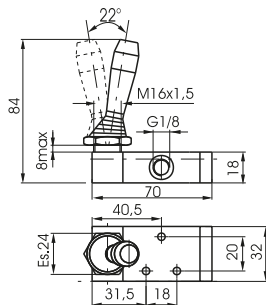

5 ways



Weight 160 g

228.52.9/C

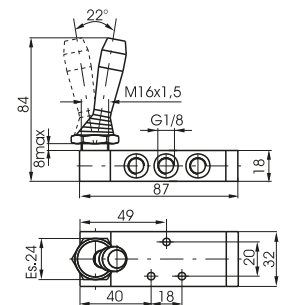

Pedal aluminium 2 positions

Coding: 228.1.10

Operational characteristics	
Fluid	Filtered air. No lubrication needed, if applied it shall be continuous
Max working pressure (bar)	10
Temperature °C	-5 ÷ +70
Flow rate at 6 bar with $\Delta p=1$ (NI/min)	540
Orifice size (mm)	6
Working ports size	G1/8"

T	TYPE
	32 = 3 ways 52 = 5 ways

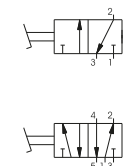

3 ways



Weight 790 g

228.32.10

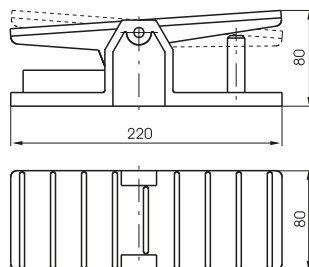

5 ways



Weight 810 g

228.52.10

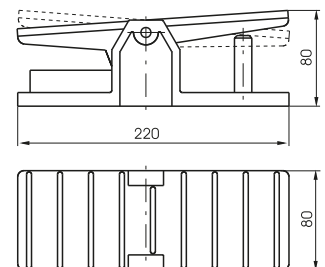

Pedal aluminium - Spring

Coding: 228.Ⓣ.10.1

Operational characteristics

Fluid	Filtered air. No lubrication needed, if applied it shall be continuous
Max working pressure (bar)	10
Temperature °C	-5 ÷ +70
Flow rate at 6 bar with Δp=1 (NI/min)	540
Orifice size (mm)	6
Working ports size	G1/8"

TYPE	
Ⓣ 32 = 3 ways	
52 = 5 ways	

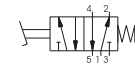
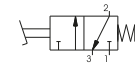

3 ways

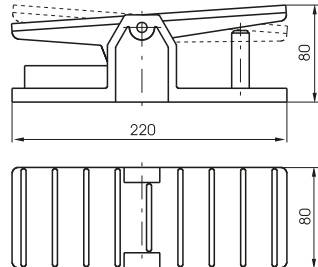

Weight 790 g

228.32.10.1

5 ways

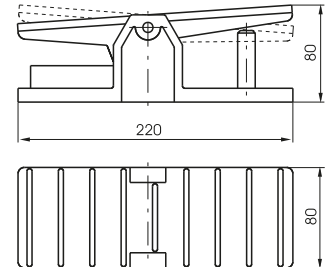

Weight 810 g

228.52.10.1

Pedal protected - Spring

Coding: 228.Ⓣ.10.Ⓥ

Operational characteristics

Fluid	Filtered air. No lubrication needed, if applied it shall be continuous
Max working pressure (bar)	10
Temperature °C	-5 ÷ +70
Flow rate at 6 bar with Δp=1 (NI/min)	540
Orifice size (mm)	6
Working ports size	G1/8"

TYPE	
Ⓣ 32 = 3 ways	
52 = 5 ways	
VERSION	
Ⓥ 1/1 = Standard version	
2/1 = without safety device	

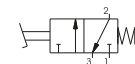

3 ways

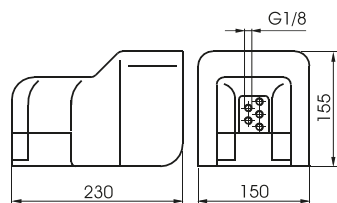

Weight 1120 g

228.32.10.Ⓥ

5 ways

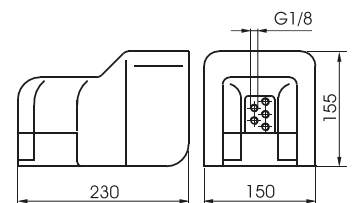

Weight 1120 g

228.52.10.Ⓥ

Pedal protected 2 positions

Coding: 228.Ⓣ.10/1

Operational characteristics

Fluid	Filtered air. No lubrication needed, if applied it shall be continuous
Max working pressure (bar)	10
Temperature °C	-5 ÷ +70
Flow rate at 6 bar with Δp=1 (NI/min)	540
Orifice size (mm)	6
Working ports size	G1/8"

TYPE	
Ⓣ 32 = 3 ways	
52 = 5 ways	

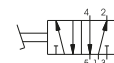
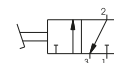

3 ways

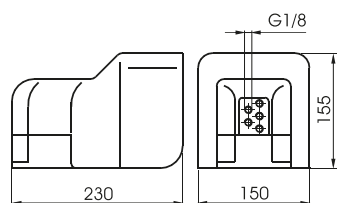

Weight 1120 g

228.32.10/1

5 ways

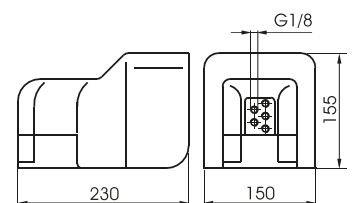

Weight 1120 g

228.52.10/1

Pedal plastic miniaturized - Spring

Coding: 228.52.10.F

Operational characteristics	
Fluid	Filtered air. No lubrication needed, if applied it shall be continuous
Max working pressure (bar)	10
Temperature °C	-5 ÷ +70
Flow rate at 6 bar with $\Delta p=1$ (NI/min)	540
Orifice size (mm)	6
Working ports size	G1/8"

FUNCTION	
F	1P = Standard version
	1PX = Stainless steel spool

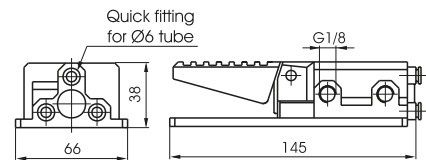

Weight 230 g



Lever lateral spring centre 3 positions

Coding: 228.53.F.9.1/C

Operational characteristics	
Fluid	Filtered air. No lubrication needed, if applied it shall be continuous
Max working pressure (bar)	10
Temperature °C	-5 ÷ +70
Flow rate at 6 bar with $\Delta p=1$ (NI/min)	540
Orifice size (mm)	6
Working ports size	G1/8"

FUNCTION	
F	31 = Closed centres
	32 = Open centres
	33 = Pressured centres
LEVER COLOR	
C	1 = Red
	2 = Black
	3 = Green

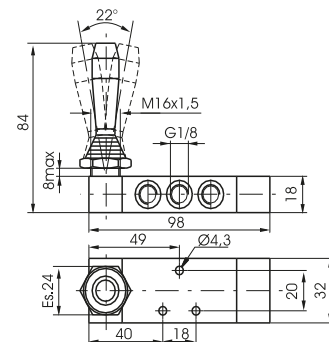
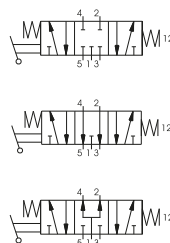

Weight 190 g

Lever lateral 3 positions detent

Coding: 228.53.F.9/C

Operational characteristics	
Fluid	Filtered air. No lubrication needed, if applied it shall be continuous
Max working pressure (bar)	10
Temperature °C	-5 ÷ +70
Flow rate at 6 bar with $\Delta p=1$ (NI/min)	540
Orifice size (mm)	6
Working ports size	G1/8"

FUNCTION	
F	31 = Closed centres
	32 = Open centres
	33 = Pressured centres
LEVER COLOR	
C	1 = Red
	2 = Black
	3 = Green

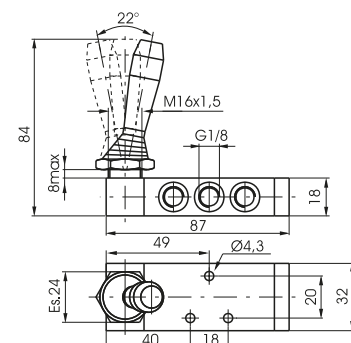
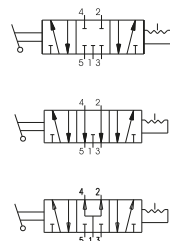

Weight 160 g



1
AIR DISTRIBUTION

Lever central (spring 3 pos.) Operator, Levar, Spole in Technopolymer

Coding: 228.53.32.99P/C

Operational characteristics	
Fluid	Filtered air. No lubrication needed, if applied it shall be continuous
Max working pressure (bar)	10
Temperature °C	-5 ÷ +70
Flow rate at 6 bar with $\Delta p=1$ (NI/min)	410
Orifice size (mm)	6
Working ports size	G1/8"

LEVER COLOR	
1	= Red
2	= Black



Weight 140 g

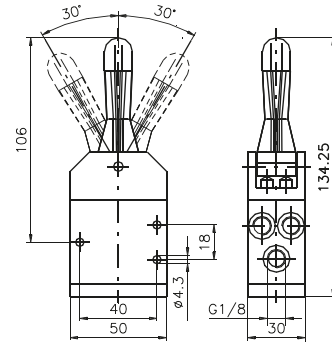
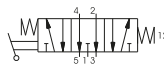

Lever central (spring 3 pos.) Levar in Technopolymer

Coding: 228.53.32.99/C

Operational characteristics	
Fluid	Filtered air. No lubrication needed, if applied it shall be continuous
Max working pressure (bar)	10
Temperature °C	-5 ÷ +70
Flow rate at 6 bar with $\Delta p=1$ (NI/min)	410
Orifice size (mm)	6
Working ports size	G1/8"

LEVER COLOR	
1	= Red
2	= Black



Weight 140 g

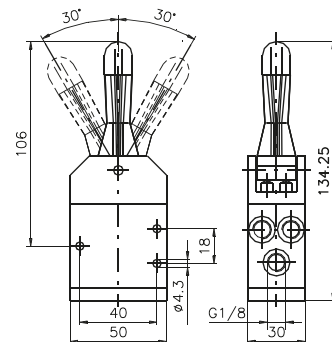
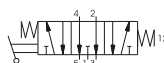

Lever central Metal (spring 3 pos.) One position stable

Coding: 228.53.32.99/C.S

Operational characteristics	
Fluid	Filtered air. No lubrication needed, if applied it shall be continuous
Max working pressure (bar)	10
Temperature °C	-5 ÷ +70
Flow rate at 6 bar with $\Delta p=1$ (NI/min)	410
Orifice size (mm)	6
Working ports size	G1/8"

LEVER COLOR	
1	= Red
2	= Black



Weight 140 g

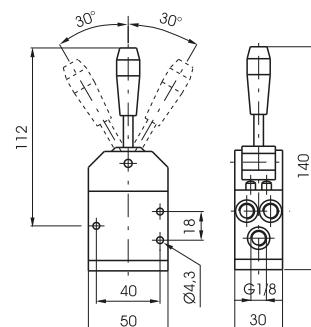
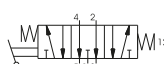

Lever central Metal

Coding: 228.53.32.99.F/C

Operational characteristics	
Fluid	Filtered air. No lubrication needed, if applied it shall be continuous
Max working pressure (bar)	10
Temperature °C	-5 ÷ +70
Flow rate at 6 bar with Δp=1 (NI/min)	410
Orifice size (mm)	6
Working ports size	G1/8"

F	FUNCTION
	2 = 2 Stable positions
	3 = 3 pos. stable
C	LEVER COLOR
	1 = Red 2 = Black

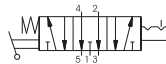
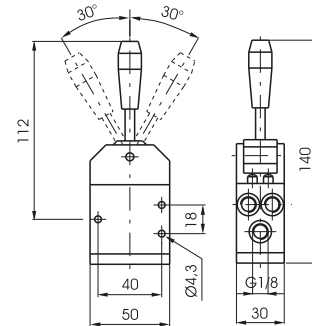

Weight 140 g

Pedal - Spring 3 positions

Coding: 228.53.F.10.1

Operational characteristics	
Fluid	Filtered air. No lubrication needed, if applied it shall be continuous
Max working pressure (bar)	10
Temperature °C	-5 ÷ +70
Flow rate at 6 bar with Δp=1 (NI/min)	410
Orifice size (mm)	6
Working ports size	G1/8"

F	FUNCTION
	31 = Closed centres
	32 = Open centres

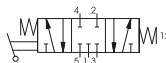
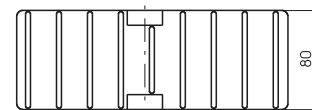
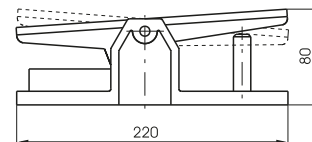

Weight 810 g

1
AIR DISTRIBUTION



Pneumatic - Spring

Coding: 228.11.1

Operational characteristics

Fluid	Filtered air. No lubrication needed, if applied it shall be continuous
Max working pressure (bar)	10
Temperature °C	-5 ÷ +70
Flow rate at 6 bar with Δp=1 (NI/min)	540
Orifice size (mm)	6
Working ports size	G1/8"
Pilot ports size	G1/8"

TYPE	
32 = 3 ways	
52 = 5 ways	

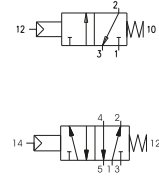

3 ways

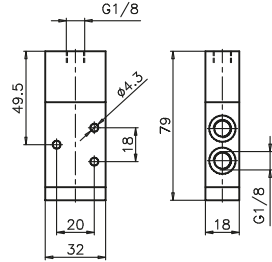

Weight 110 g
Minimum piloting pressure 2,5 bar

228.32.11.1

5 ways

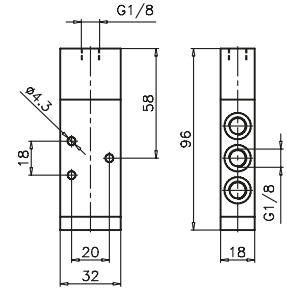

Weight 130 g
Minimum piloting pressure 2,5 bar

228.52.11.1

Pneumatic - Differential external

Coding: 228.11.12

Operational characteristics

Fluid	Filtered air. No lubrication needed, if applied it shall be continuous
Max working pressure (bar)	10
Temperature °C	-5 ÷ +70
Flow rate at 6 bar with Δp=1 (NI/min)	540
Orifice size (mm)	6
Working ports size	G1/8"
Pilot ports size	G1/8"

TYPE	
32 = 3 ways	
52 = 5 ways	

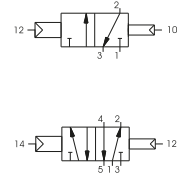

3 ways

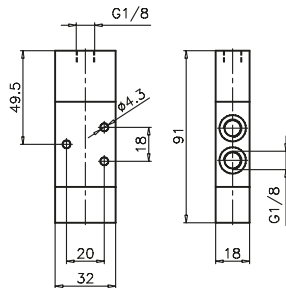

Weight 140 g
Minimum piloting pressure 2,5 bar

228.32.11.12

5 ways

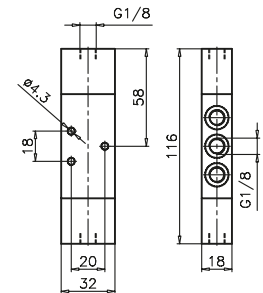

Weight 160 g
Minimum piloting pressure 2,5 bar

228.52.11.12

Pneumatic - Differential self aligned

Coding: 228.11.12/1

Operational characteristics

Fluid	Filtered air. No lubrication needed, if applied it shall be continuous
Max working pressure (bar)	10
Temperature °C	-5 ÷ +70
Flow rate at 6 bar with Δp=1 (NI/min)	540
Orifice size (mm)	6
Working ports size	G1/8"
Pilot ports size	G1/8"

TYPE	
32 = 3 ways	
52 = 5 ways	

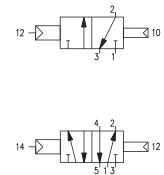

3 ways

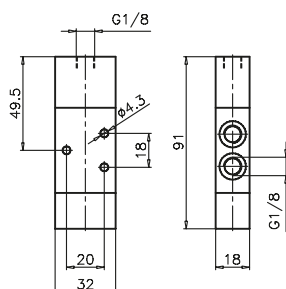

Weight 130 g
Minimum piloting pressure 2,5 bar

228.32.11.12/1

5 ways

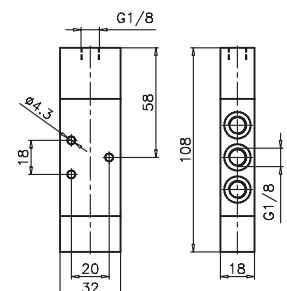

Weight 150 g
Minimum piloting pressure 2,5 bar

228.52.11.12/1

AIR DISTRIBUTION

Pneumatic - Pneumatic

Coding: 228.1.11.11

Operational characteristics	
Fluid	Filtered air. No lubrication needed, if applied it shall be continuous
Max working pressure (bar)	10
Temperature °C	-5 ÷ +70
Flow rate at 6 bar with Δp=1 (NI/min)	540
Orifice size (mm)	6
Working ports size	G1/8"
Pilot ports size	G1/8"

TYPE	
32	= 3 ways
52	= 5 ways

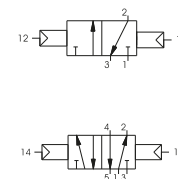

3 ways

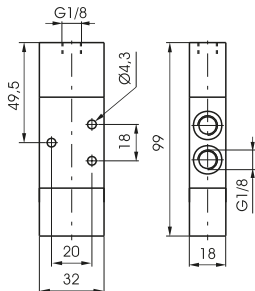

Weight 140 g
Minimum piloting pressure 2 bar

228.32.11.11

5 ways

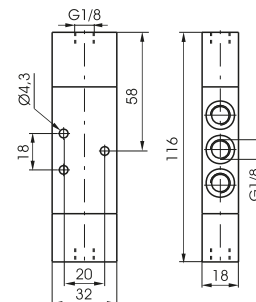

Weight 160 g
Minimum piloting pressure 2 bar

228.52.11.11

Amplified pneumatic - Spring

Coding: 228.1.13.1

Operational characteristics	
Fluid	Filtered air. No lubrication needed, if applied it shall be continuous
Max working pressure (bar)	10
Temperature °C	-5 ÷ +70
Flow rate at 6 bar with Δp=1 (NI/min)	540
Orifice size (mm)	6
Working ports size	G1/8"
Pilot ports size	G1/8"

TYPE	
32	= 3 ways
52	= 5 ways

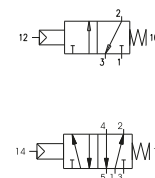

3 ways

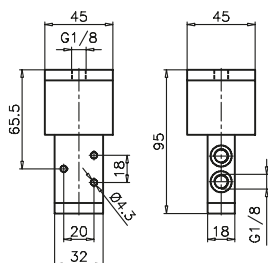

Weight 260 g
Minimum piloting pressure 0,5 bar

228.32.13.1

5 ways

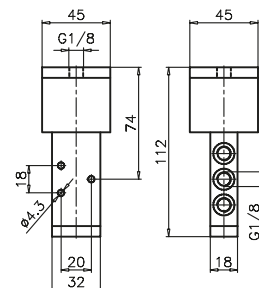

Weight 290 g
Minimum piloting pressure 0,5 bar

228.52.13.1

Pneumatic - Pneumatic 5 ways 3 connections

Coding: 228.53.F.11.11

Operational characteristics	
Fluid	Filtered air. No lubrication needed, if applied it shall be continuous
Max working pressure (bar)	10
Temperature °C	-5 ÷ +70
Flow rate at 6 bar with Δp=1 (NI/min)	410
Orifice size (mm)	6
Working ports size	G1/8"
Pilot ports size	G1/8"

FUNCTION	
31	= Closed centres
32	= Open centres
33	= Pressured centres

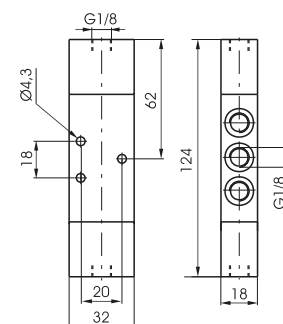
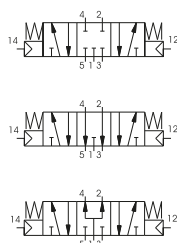

Weight 180 g
Minimum piloting pressure 3 bar

228.53.F.11.11

Tappet panel - Spring

Coding: 224.1.1

Operational characteristics

Fluid	Filtered air. No lubrication needed, if applied it shall be continuous
Max working pressure (bar)	10
Temperature °C	-5 ÷ +70
Flow rate at 6 bar with Δp=1 (NI/min)	1360
Orifice size (mm)	8
Working ports size	G1/4"

TYPE
① 32 = 3 ways
52 = 5 ways

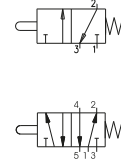

3 ways

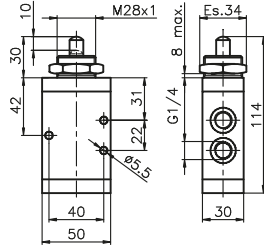

Weight 370 g
Operating force 71,5 N

224.32.1.1

5 ways

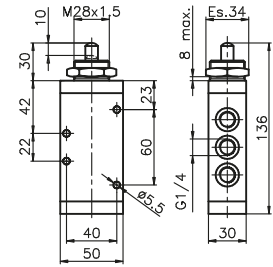

Weight 455 g
Operating force 71,5 N

224.52.1.1

Lever roller - Spring

Coding: 224.2.1

Operational characteristics

Fluid	Filtered air. No lubrication needed, if applied it shall be continuous
Max working pressure (bar)	10
Temperature °C	-5 ÷ +70
Flow rate at 6 bar with Δp=1 (NI/min)	1360
Orifice size (mm)	8
Working ports size	G1/4"

TYPE
① 32 = 3 ways
52 = 5 ways

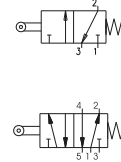

3 ways

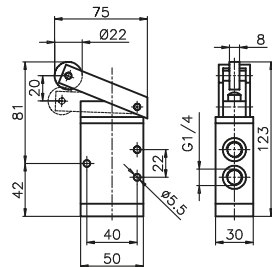

Weight 510 g
Operating force 35 N

224.32.2.1

5 ways

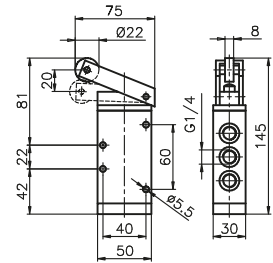

Weight 595 g
Operating force 35 N

224.52.2.1

Lever roller unidirectional - Spring

Coding: 224.3.1

Operational characteristics

Fluid	Filtered air. No lubrication needed, if applied it shall be continuous
Max working pressure (bar)	10
Temperature °C	-5 ÷ +70
Flow rate at 6 bar with Δp=1 (NI/min)	1360
Orifice size (mm)	8
Working ports size	G1/4"

TYPE
① 32 = 3 ways
52 = 5 ways

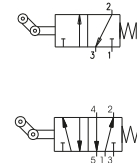

3 ways

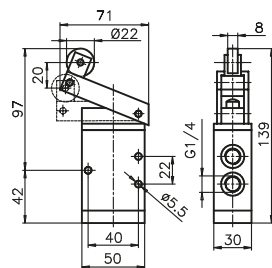

Weight 525 g
Operating force 35 N

224.32.3.1

5 ways

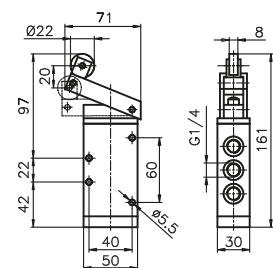

Weight 610 g
Operating force 35 N

224.52.3.1

Push button - Spring

Coding: 224.1.8.1

Operational characteristics	
Fluid	Filtered air. No lubrication needed, if applied it shall be continuous
Max working pressure (bar)	10
Temperature °C	-5 ÷ +70
Flow rate at 6 bar with Δp=1 (NI/min)	1360
Orifice size (mm)	8
Working ports size	G1/4"

TYPE	
32	= 3 ways
52	= 5 ways

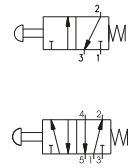

3 ways



Weight 395 g
Operating force 71,5 N

224.32.8.1

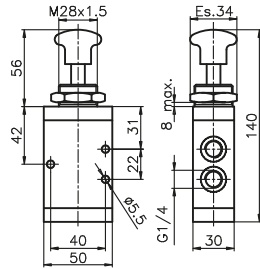

5 ways



Weight 480 g
Operating force 71,5 N

224.52.8.1

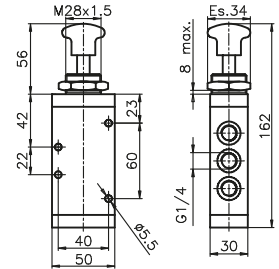

1
AIR DISTRIBUTION

Push button 2 positions

Coding: 224.1.8

Operational characteristics	
Fluid	Filtered air. No lubrication needed, if applied it shall be continuous
Max working pressure (bar)	10
Temperature °C	-5 ÷ +70
Flow rate at 6 bar with Δp=1 (NI/min)	1360
Orifice size (mm)	8
Working ports size	G1/4"

TYPE	
32	= 3 ways
52	= 5 ways

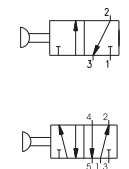

3 ways



Weight 385 g
Operating force 13 N

224.32.8

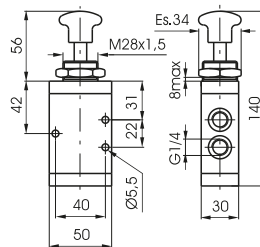

5 ways



Weight 470 g
Operating force 13 N

224.52.8

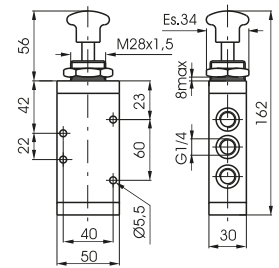

Lever lateral - Spring

Coding: 224.1.9.1/C

Operational characteristics	
Fluid	Filtered air. No lubrication needed, if applied it shall be continuous
Max working pressure (bar)	10
Temperature °C	-5 ÷ +70
Flow rate at 6 bar with Δp=1 (NI/min)	1360
Orifice size (mm)	8
Working ports size	G1/4"

TYPE	
32	= 3 ways
52	= 5 ways
LEVER COLOR	
1	= Red
2	= Black
3	= Green

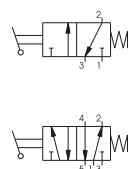

3 ways



Weight 520 g

224.32.9.1/C

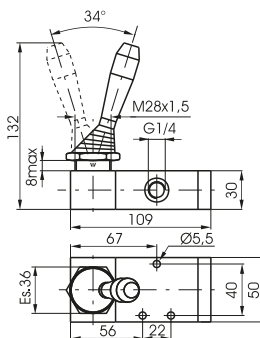

5 ways



Weight 605 g

224.52.9.1/C

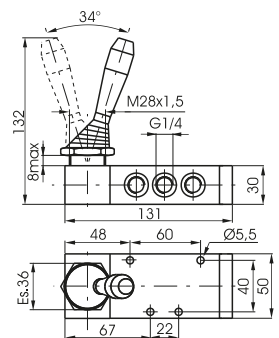



Lever lateral 2 positions

Coding: 224.1.9/C

Operational characteristics

Fluid	Filtered air. No lubrication needed, if applied it shall be continuous
Max working pressure (bar)	10
Temperature °C	-5 ÷ +70
Flow rate at 6 bar with Δp=1 (NI/min)	1360
Orifice size (mm)	8
Working ports size	G1/4"

TYPE	32 = 3 ways 52 = 5 ways
LEVER COLOR	1 = Red 2 = Black 3 = Green

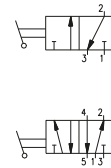

1 AIR DISTRIBUTION

3 ways



Weight 510 g

224.32.9/C

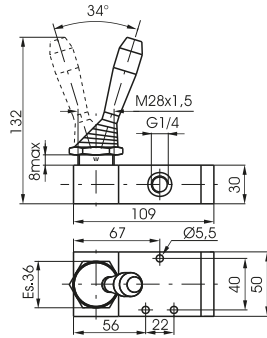

5 ways



Weight 595 g

224.52.9/C

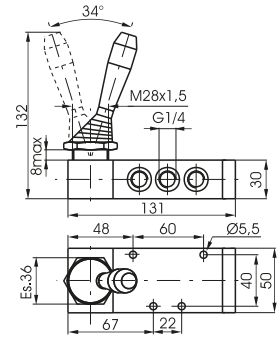

Pedal aluminium - Spring

Coding: 224.1.10.1

Operational characteristics

Fluid	Filtered air. No lubrication needed, if applied it shall be continuous
Max working pressure (bar)	10
Temperature °C	-5 ÷ +70
Flow rate at 6 bar with Δp=1 (NI/min)	1360
Orifice size (mm)	8
Working ports size	G1/4"

TYPE	32 = 3 ways 52 = 5 ways
------	----------------------------

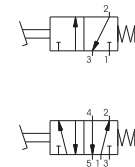

3 ways



Weight 1070 g

224.32.10.1

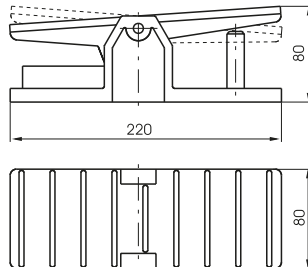

5 ways



Weight 1155 g

224.52.10.1

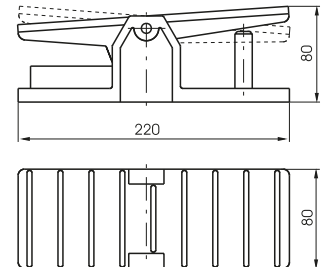

Pedal aluminium 2 positions

Coding: 224.1.10

Operational characteristics

Fluid	Filtered air. No lubrication needed, if applied it shall be continuous
Max working pressure (bar)	10
Temperature °C	-5 ÷ +70
Flow rate at 6 bar with Δp=1 (NI/min)	1360
Orifice size (mm)	8
Working ports size	G1/4"

TYPE	32 = 3 ways 52 = 5 ways
------	----------------------------

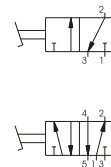

3 ways



Weight 1060 g

224.32.10

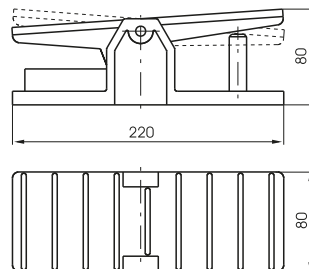

5 ways



Weight 1145 g

224.52.10

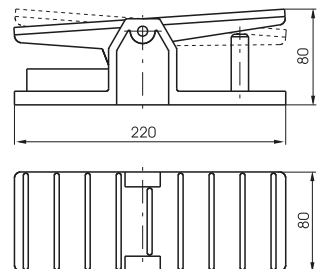

Lateral Lever spring - 3 positions

Coding: 224.53.F.9.1/C

Operational characteristics	
Fluid	Filtered air. No lubrication needed, if applied it shall be continuous
Max working pressure (bar)	10
Temperature °C	-5 ÷ +70
Flow rate at 6 bar with Δp=1 (NI/min)	1280
Orifice size (mm)	8
Working ports size	G1/4"

F	FUNCTION
	31 = Closed centres 32 = Open centres
C	LEVER COLOR
	1 = Red 2 = Black 3 = Green



Weight 745 g

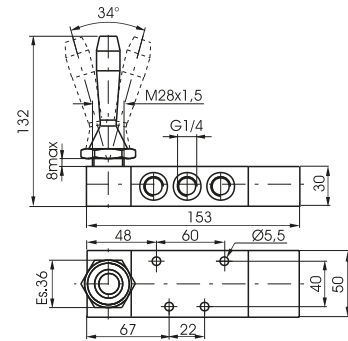
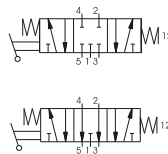

Lever lateral 3 positions detent

Coding: 224.53.F.9/C

Operational characteristics	
Fluid	Filtered air. No lubrication needed, if applied it shall be continuous
Max working pressure (bar)	10
Temperature °C	-5 ÷ +70
Flow rate at 6 bar with Δp=1 (NI/min)	1280
Orifice size (mm)	8
Working ports size	G1/4"

F	FUNCTION
	31 = Closed centres 32 = Open centres
C	LEVER COLOR
	1 = Red 2 = Black 3 = Green



Weight 605 g

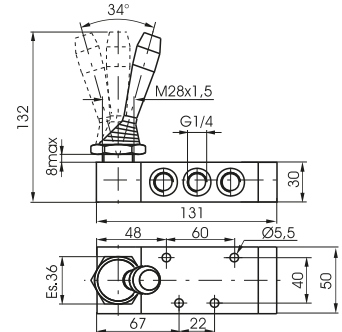
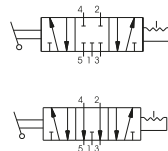

Lever lateral with locking device - 2 positions

Coding: 224.52.9.2

Operational characteristics	
Fluid	Filtered air. No lubrication needed, if applied it shall be continuous
Max working pressure (bar)	10
Temperature °C	-5 ÷ +70
Flow rate at 6 bar with Δp=1 (NI/min)	1020
Orifice size (mm)	8
Working ports size	G1/4"



Weight 825 g

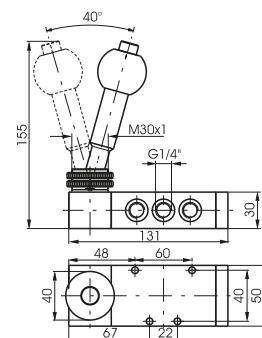

1
AIR DISTRIBUTION

Lever lateral with locking device - Spring 3 positions

Coding: 224.53.F.9.2

Operational characteristics	
Fluid	Filtered air. No lubrication needed, if applied it shall be continuous
Max working pressure (bar)	10
Temperature °C	-5 ÷ +70
Flow rate at 6 bar with Δp=1 (NI/min)	1020
Orifice size (mm)	8
Working ports size	G1/4"

FUNCTION	
F	31 = Closed centres
	32 = Open centres



Weight 965 g

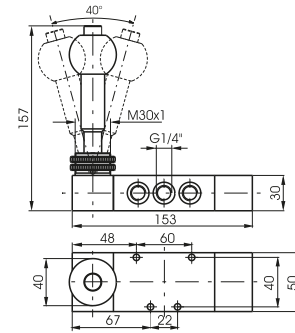
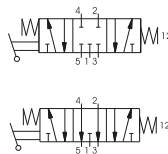

Pedal - Spring 3 positions

Coding: 224.53.F.10.1

Operational characteristics	
Fluid	Filtered air. No lubrication needed, if applied it shall be continuous
Max working pressure (bar)	10
Temperature °C	-5 ÷ +70
Flow rate at 6 bar with Δp=1 (NI/min)	1280
Orifice size (mm)	8
Working ports size	G1/4"

FUNCTION	
F	31 = Closed centres
	32 = Open centres



Weight 1285 g

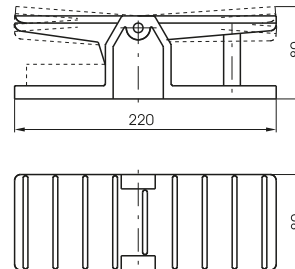
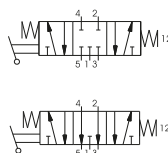

Pedal 3 positions

Coding: 224.53.F.10

Operational characteristics	
Fluid	Filtered air. No lubrication needed, if applied it shall be continuous
Max working pressure (bar)	10
Temperature °C	-5 ÷ +70
Flow rate at 6 bar with Δp=1 (NI/min)	1280
Orifice size (mm)	8
Working ports size	G1/4"

FUNCTION	
F	31 = Closed centres
	32 = Open centres



Weight 1145 g

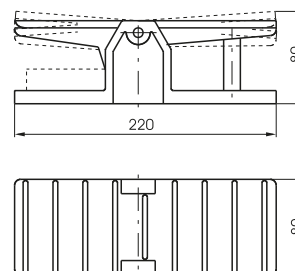
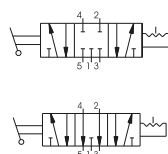

Pneumatic - Spring

Coding: 224.11.1

Operational characteristics	
Fluid	Filtered air. No lubrication needed, if applied it shall be continuous
Max working pressure (bar)	10
Temperature °C	-5 ÷ +70
Flow rate at 6 bar with $\Delta p=1$ (NI/min)	1360
Orifice size (mm)	8
Working ports size	G1/4"
Pilot ports size	G1/8"

TYPE	
32	= 3 ways
52	= 5 ways

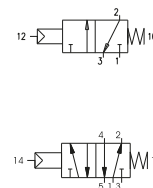

Weight 370 g
Minimum piloting pressure 2,5 bar

224.32.11.1

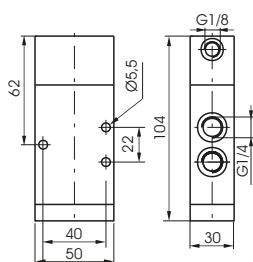

5 ways



Weight 450 g
Minimum piloting pressure 2,5 bar

224.52.11.1

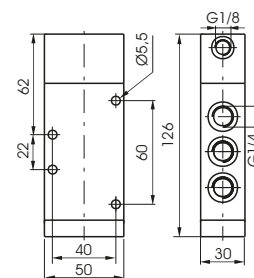

Pneumatic - Differential external

Coding: 224.11.12

Operational characteristics	
Fluid	Filtered air. No lubrication needed, if applied it shall be continuous
Max working pressure (bar)	11
Temperature °C	-5 ÷ +70
Flow rate at 6 bar with $\Delta p=1$ (NI/min)	1360
Orifice size (mm)	8
Working ports size	G1/4"
Pilot ports size	G1/8"

TYPE	
32	= 3 ways
52	= 5 ways

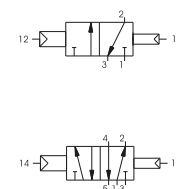

3 ways



Weight 480 g
Minimum piloting pressure 2,5 bar

224.32.11.12

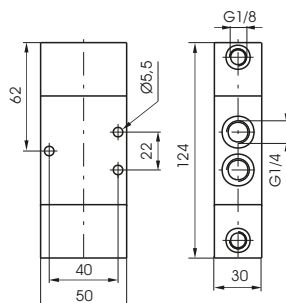

5 ways



Weight 550 g
Minimum piloting pressure 2,5 bar

224.52.11.12

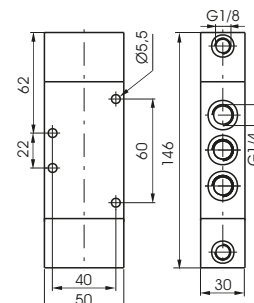

Pneumatic - Pneumatic

Coding: 224.11.11

Operational characteristics	
Fluid	Filtered air. No lubrication needed, if applied it shall be continuous
Max working pressure (bar)	12
Temperature °C	-5 ÷ +70
Flow rate at 6 bar with $\Delta p=1$ (NI/min)	1360
Orifice size (mm)	8
Working ports size	G1/4"
Pilot ports size	G1/8"

TYPE	
32	= 3 ways
52	= 5 ways

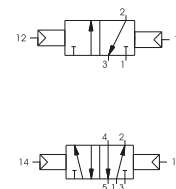

3 ways



Weight 470 g
Minimum piloting pressure 2 bar

224.32.11.11

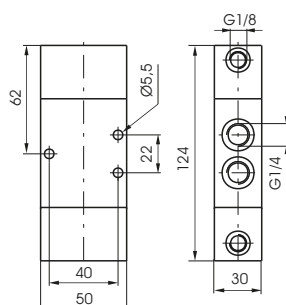

5 ways



Weight 540 g
Minimum piloting pressure 2 bar

224.52.11.11

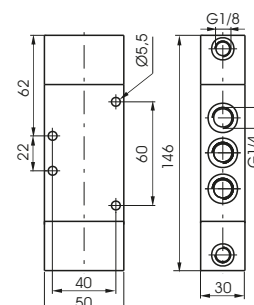



Pneumatic - Pneumatic 5 ways 3 connections

Coding: 224.53.F.11.11

Operational characteristics

Fluid	Filtered air. No lubrication needed, if applied it shall be continuous
Max working pressure (bar)	13
Temperature °C	-5 ÷ +70
Flow rate at 6 bar with $\Delta p=1$ (NI/min)	1280
Orifice size (mm)	8
Working ports size	G1/4"
Pilot ports size	G1/8"

FUNCTION	
F	31 = Closed centres
	32 = Open centres
	33 = Pressured centres

1
AIR DISTRIBUTION

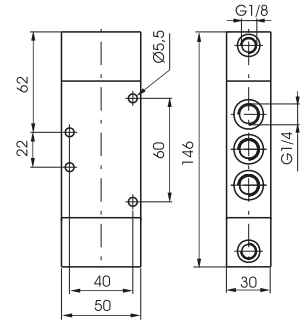
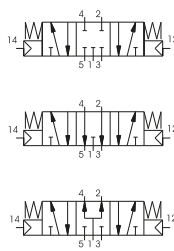

Weight 550 g
 Minimum piloting pressure 3 bar

Pedal protected 2 positions

Coding: 214. **T**.10/1

Operational characteristics	
Fluid	Filtered air. No lubrication needed, if applied it shall be continuous
Max working pressure (bar)	10
Temperature °C	-5 ÷ +70
Flow rate at 6 bar with Δp=1 (NI/min)	1360
Orifice size (mm)	8
Working ports size	G1/4"

T	TYPE
	32 = 3 ways
	52 = 5 ways

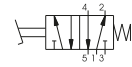
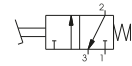

3 ways

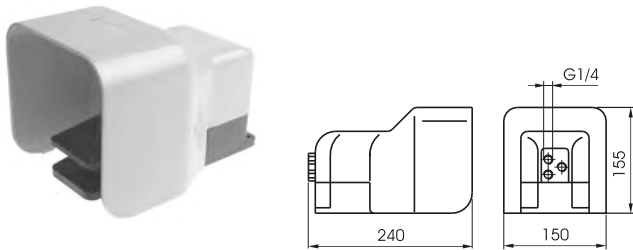

Weight 1730 g

214.32.10. **V**

5 ways

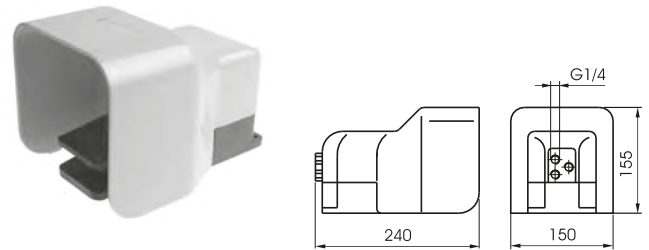

Weight 1730 g

214.52.10. **V**

Pedal protected - Spring

Coding: 214. **T**.10. **V**

Operational characteristics	
Fluid	Filtered air. No lubrication needed, if applied it shall be continuous
Max working pressure (bar)	10
Temperature °C	-5 ÷ +70
Flow rate at 6 bar with Δp=1 (NI/min)	1360
Orifice size (mm)	8
Working ports size	G1/4"

T	TYPE
	32 = 3 ways
	52 = 5 ways
V	VERSION
	1/1 = Standard version
	2/1 = without safety device

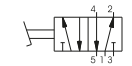
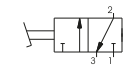

3 ways

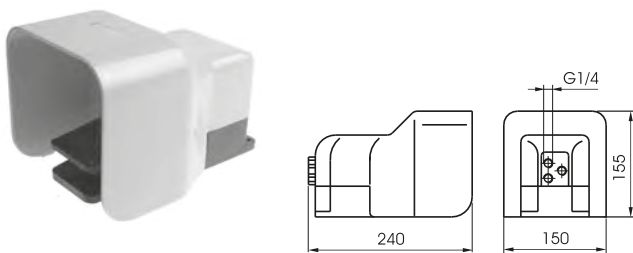

Weight 1730 g

214.32.10/1

5 ways

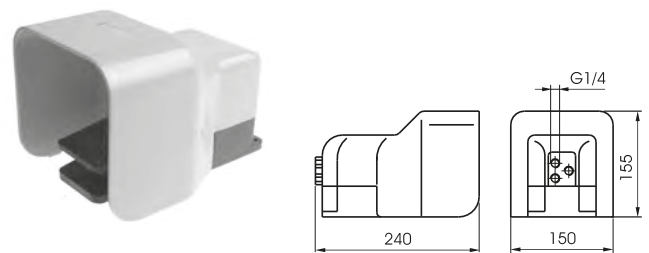

Weight 1730 g

214.52.10/1

1
AIR DISTRIBUTION

Lever lateral - Spring

Coding: 212. **T**.9.1

Operational characteristics

Fluid	Filtered air. No lubrication needed, if applied it shall be continuous
Max working pressure (bar)	10
Temperature °C	-5 ÷ +70
Flow rate at 6 bar with Δp=1 (NI/min)	3500
Orifice size (mm)	15
Working ports size	G1/2"

TYPE
T 32 = 3 ways
52 = 5 ways

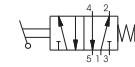
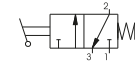

3 ways

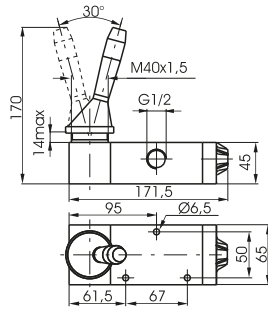

Weight 1480 g

212.32.9.1

5 ways

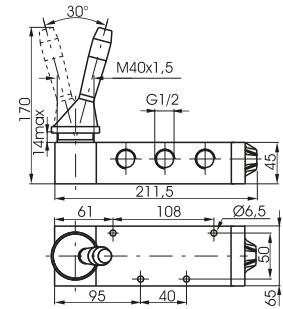

Weight 1765 g

212.52.9.1

Lever lateral 2 positions

Coding: 212. **T**.9

Operational characteristics

Fluid	Filtered air. No lubrication needed, if applied it shall be continuous
Max working pressure (bar)	10
Temperature °C	-5 ÷ +70
Flow rate at 6 bar with Δp=1 (NI/min)	3500
Orifice size (mm)	15
Working ports size	G1/2"

TYPE
T 32 = 3 ways
52 = 5 ways

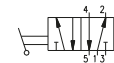
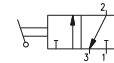

3 ways

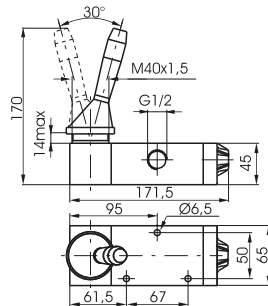

Weight 1460 g

212.32.9

5 ways

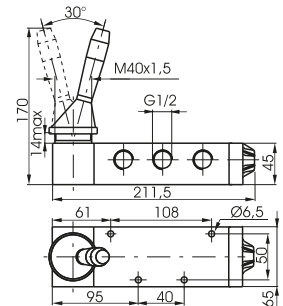

Weight 1745 g

212.52.9

Lever lateral spring centre 3 positions

Coding: 212.53. **F**.9.1

Operational characteristics

Fluid	Filtered air. No lubrication needed, if applied it shall be continuous
Max working pressure (bar)	10
Temperature °C	-5 ÷ +70
Flow rate at 6 bar with Δp=1 (NI/min)	3000
Orifice size (mm)	15
Working ports size	G1/2"

FUNCTION
F 31 = Closed centres
32 = Open centres

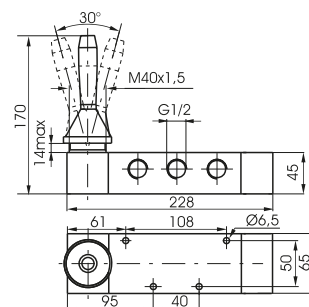
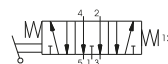
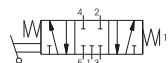

Weight 2100 g

AIR DISTRIBUTION

Lever lateral 3 positions detent

Coding: 212.53.Ⓕ.9

Operational characteristics	
Fluid	Filtered air. No lubrication needed, if applied it shall be continuous
Max working pressure (bar)	10
Temperature °C	-5 ÷ +70
Flow rate at 6 bar with Δp=1 (Nl/min)	3000
Orifice size (mm)	15
Working ports size	G1/2"

FUNCTION	
Ⓕ	31 = Closed centres
	32 = Open centres



Weight 1765 g

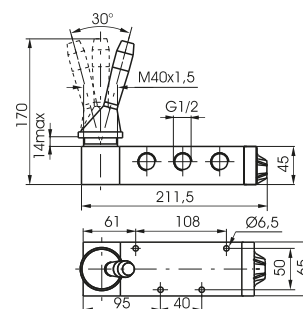
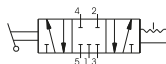

Pneumatic - Spring

Coding: 212.11.1

Operational characteristics

Fluid	Filtered air. No lubrication needed, if applied it shall be continuous
Max working pressure (bar)	10
Temperature °C	-5 ÷ +70
Flow rate at 6 bar with Δp=1 (NI/min)	3500
Orifice size (mm)	15
Working ports size	G1/2"
Pilot ports size	G1/8"

TYPE	
32 = 3 ways	
52 = 5 ways	

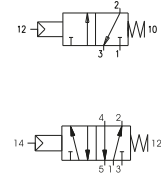

3 ways

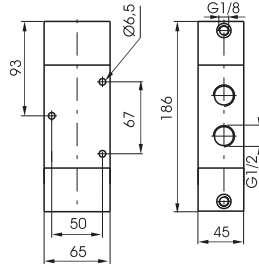

Weight 1110 g
Minimum piloting pressure 2,5 bar

212.32.11.1

5 ways

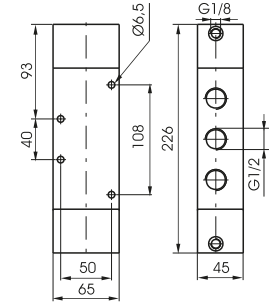

Weight 1390 g
Minimum piloting pressure 2,5 bar

212.52.11.1

Pneumatic - Differential external

Coding: 212.11.12

Operational characteristics

Fluid	Filtered air. No lubrication needed, if applied it shall be continuous
Max working pressure (bar)	10
Temperature °C	-5 ÷ +70
Flow rate at 6 bar with Δp=1 (NI/min)	3500
Orifice size (mm)	15
Working ports size	G1/2"
Pilot ports size	G1/8"

TYPE	
32 = 3 ways	
52 = 5 ways	

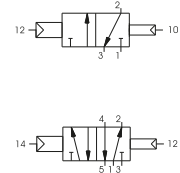

3 ways

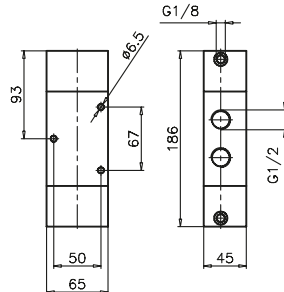

Weight 1380 g
Minimum piloting pressure 2,5 bar

212.32.11.12

5 ways

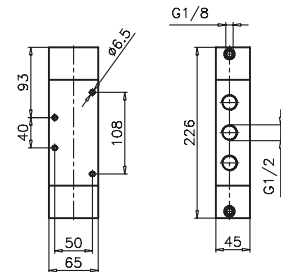

Weight 1660 g
Minimum piloting pressure 2,5 bar

212.52.11.12

Pneumatic - Pneumatic

Coding: 212.11.11

Operational characteristics

Fluid	Filtered air. No lubrication needed, if applied it shall be continuous
Max working pressure (bar)	10
Temperature °C	-5 ÷ +70
Flow rate at 6 bar with Δp=1 (NI/min)	3500
Orifice size (mm)	15
Working ports size	G1/2"
Pilot ports size	G1/8"

TYPE	
32 = 3 ways	
52 = 5 ways	

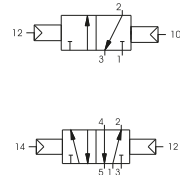

3 ways

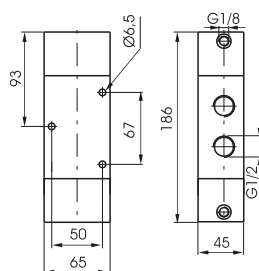

Weight 1350 g
Minimum piloting pressure 2 bar

212.32.11.11

5 ways

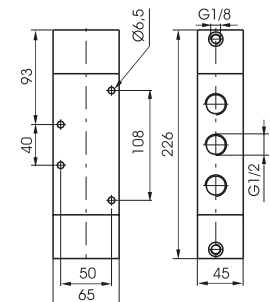

Weight 1630 g
Minimum piloting pressure 2 bar

212.52.11.11

AIR DISTRIBUTION

1

Pneumatic - Pneumatic 5 ways 3 connections

Coding: 212.53.ⓕ.11.11

Operational characteristics	
Fluid	Filtered air. No lubrication needed, if applied it shall be continuous
Max working pressure (bar)	10
Temperature °C	-5 ÷ +70
Flow rate at 6 bar with Δp=1 (Nl/min)	3000
Orifice size (mm)	15
Working ports size	G1/2"
Pilot ports size	G1/8"

FUNCTION	
ⓕ	31 = Closed centres
	32 = Open centres
	33 = Pressured centres

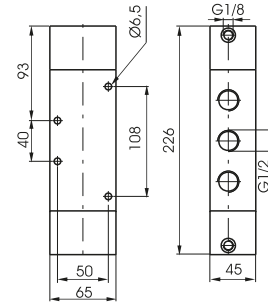
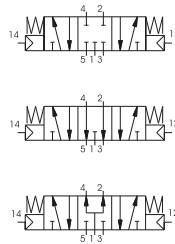

Weight 1650 g
Minimum piloting pressure 3 bar

1
AIR DISTRIBUTION

Pneumatic - Differential external

Coding: 212/2.11.1

Operational characteristics

Fluid	Filtered air. No lubrication needed, if applied it shall be continuous
Max working pressure (bar)	10
Temperature °C	-5 ÷ +70
Flow rate at 6 bar with Δp=1 (NI/min)	3600
Orifice size (mm)	15
Working ports size	G1/2"
Pilot ports size	G1/8"

TYPE
32 = 3 ways
52 = 5 ways

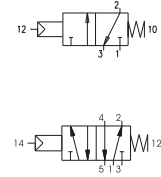

AIR DISTRIBUTION

3 ways

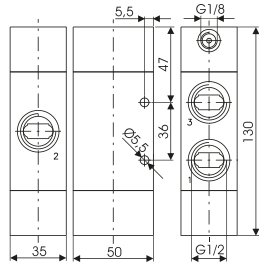

Weight 524 g
Minimum piloting pressure 2,5 bar

212/2.32.11.1

5 ways

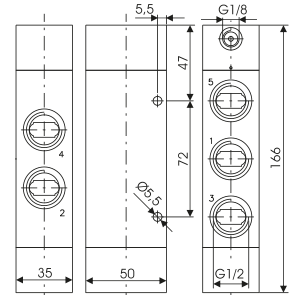

Weight 644 g
Minimum piloting pressure 2,5 bar

212/2.52.11.1

Pneumatic - Differential self aligned

Coding: 212/2.11.12

Operational characteristics

Fluid	Filtered air. No lubrication needed, if applied it shall be continuous
Max working pressure (bar)	10
Temperature °C	-5 ÷ +70
Flow rate at 6 bar with Δp=1 (NI/min)	3600
Orifice size (mm)	15
Working ports size	G1/2"
Pilot ports size	G1/8"

TYPE
32 = 3 ways
52 = 5 ways

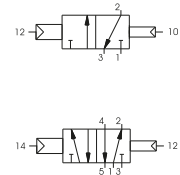

3 ways

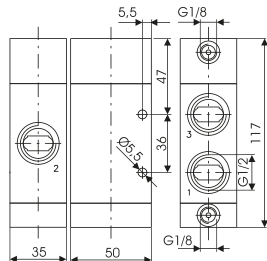

Weight 464 g
Minimum piloting pressure 2,5 bar

212/2.32.11.12

5 ways

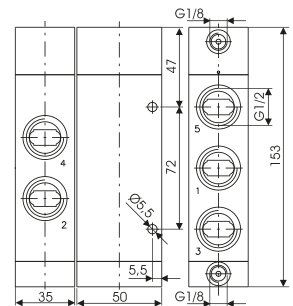

Weight 586 g
Minimum piloting pressure 2,5 bar

212/2.52.11.12

Pneumatic - Pneumatic

Coding: 212/2.11.12.F

Operational characteristics

Fluid	Filtered air. No lubrication needed, if applied it shall be continuous
Max working pressure (bar)	10
Temperature °C	-5 ÷ +70
Flow rate at 6 bar with Δp=1 (NI/min)	3600
Orifice size (mm)	15
Working ports size	G1/2"
Pilot ports size	G1/8"

TYPE
32 = 3 ways
52 = 5 ways
FUNCTION
1.C = Normally closed
1.A = Normally open
1 = Self-feeding

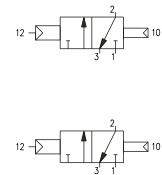

3 ways

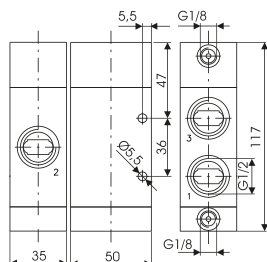

Weight 466 g
Minimum piloting pressure 2,5 bar

212/2.32.11.12/F

5 ways

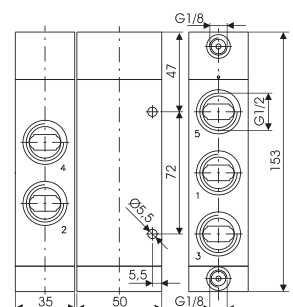

Weight 588 g
Minimum piloting pressure 2,5 bar

212/2.52.11.12/F

Amplified pneumatic - Spring

Coding: 212/2.11.11

Operational characteristics	
Fluid	Filtered air. No lubrication needed, if applied it shall be continuous
Max working pressure (bar)	10
Temperature °C	-5 ÷ +70
Flow rate at 6 bar with Δp=1 (Nl/min)	3600
Orifice size (mm)	15
Working ports size	G1/2"
Pilot ports size	G1/8"

TYPE	
32	= 3 ways
52	= 5 ways

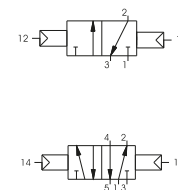

Weight 518 g
Minimum piloting pressure 2,5 bar

212/2.32.11.11

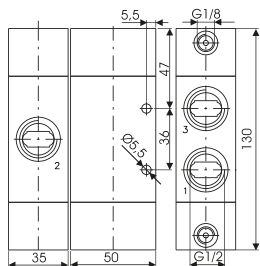

5 ways



Weight 640 g
Minimum piloting pressure 2,5 bar

212/2.52.11.11

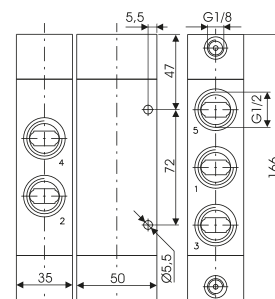

1

AIR DISTRIBUTION

Pneumatic - Pneumatic 5 ways 3 connections

Coding: 212/2.53.11.11

Operational characteristics	
Fluid	Filtered air. No lubrication needed, if applied it shall be continuous
Max working pressure (bar)	10
Temperature °C	-5 ÷ +70
Flow rate at 6 bar with Δp=1 (Nl/min)	3300
Orifice size (mm)	15
Working ports size	G1/2"
Pilot ports size	G1/8"

FUNCTION	
31	= Closed centres
32	= Open centres
33	= Pressured centres



Weight 684 g
Minimum piloting pressure 3 bar

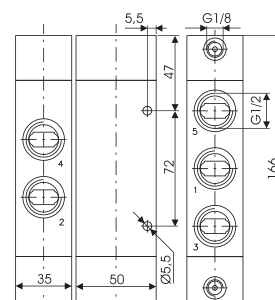
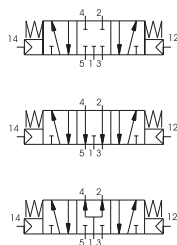



1
AIR DISTRIBUTION

Lever lateral - Spring

Coding: 211.1.9.1

Operational characteristics

Fluid	Filtered air. No lubrication needed, if applied it shall be continuous
Max working pressure (bar)	10
Temperature °C	-5 ÷ +70
Flow rate at 6 bar with Δp=1 (NI/min)	6500
Orifice size (mm)	20
Working ports size	G1"

TYPE
1 32 = 3 ways
52 = 5 ways

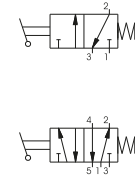

3 ways



Weight 4300 g

211.32.9.1

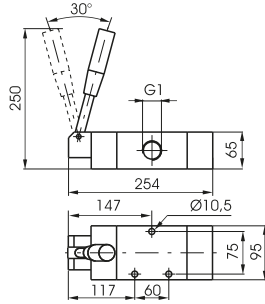

5 ways



Weight 4900 g

211.52.9.1

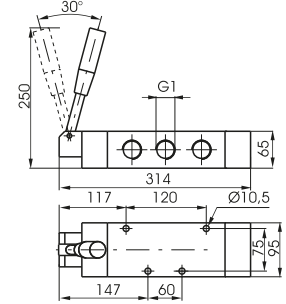

Lever lateral 2 positions

Coding: 211.1.9

Operational characteristics

Fluid	Filtered air. No lubrication needed, if applied it shall be continuous
Max working pressure (bar)	10
Temperature °C	-5 ÷ +70
Flow rate at 6 bar with Δp=1 (NI/min)	6500
Orifice size (mm)	20
Working ports size	G1"

TYPE
1 32 = 3 ways
52 = 5 ways

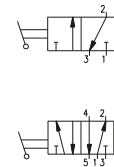

3 ways



Weight 4300 g

211.32.9

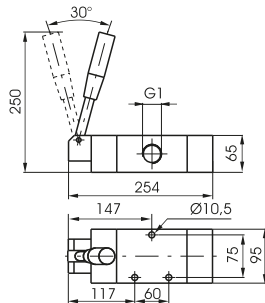

5 ways



Weight 4900 g

211.52.9

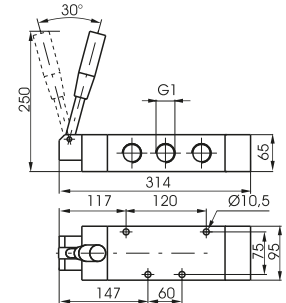

Lever lateral spring centre 3 positions

Coding: 211.53.1.9.1

Operational characteristics

Fluid	Filtered air. No lubrication needed, if applied it shall be continuous
Max working pressure (bar)	10
Temperature °C	-5 ÷ +70
Flow rate at 6 bar with Δp=1 (NI/min)	6500
Orifice size (mm)	20
Working ports size	G1"

FUNCTION
F 31 = Closed centres
32 = Open centres



Weight 5000 g

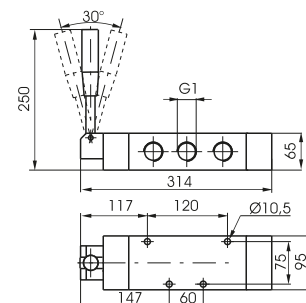
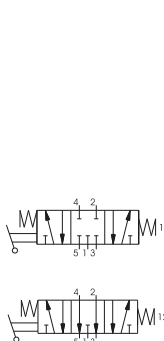

Lever lateral 3 positions detent

Coding: 211.53.F.9

Operational characteristics	
Fluid	Filtered air. No lubrication needed, if applied it shall be continuous
Max working pressure (bar)	10
Temperature °C	-5 ÷ +70
Flow rate at 6 bar with $\Delta p=1$ (l/min)	6500
Orifice size (mm)	20
Working ports size	G1"

FUNCTION	
F	31 = Closed centres
	32 = Open centres

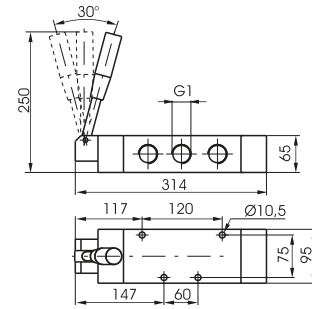
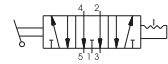
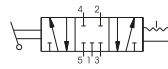

Weight 5000 g

1
AIR DISTRIBUTION

Pneumatic - Spring

Coding: 211.1.11.1

Operational characteristics

Fluid	Filtered air. No lubrication needed, if applied it shall be continuous
Max working pressure (bar)	10
Temperature °C	-5 ÷ +70
Flow rate at 6 bar with Δp=1 (NI/min)	6500
Orifice size (mm)	20
Working ports size	G1"
Pilot ports size	G1/8"

TYPE	
32 = 3 ways	
52 = 5 ways	

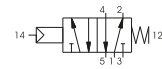
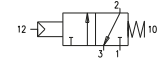

3 ways

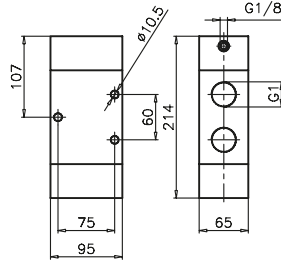

Weight 3330 g
Minimum piloting pressure 2,5 bar

211.32.11.1

5 ways

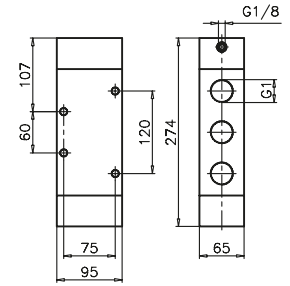

Weight 4200 g
Minimum piloting pressure 2,5 bar

211.52.11.1

Pneumatic - Differential external

Coding: 211.1.11.12

Operational characteristics

Fluid	Filtered air. No lubrication needed, if applied it shall be continuous
Max working pressure (bar)	10
Temperature °C	-5 ÷ +70
Flow rate at 6 bar with Δp=1 (NI/min)	6500
Orifice size (mm)	20
Working ports size	G1"
Pilot ports size	G1/8"

TYPE	
32 = 3 ways	
52 = 5 ways	

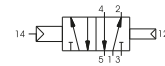
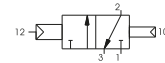

3 ways

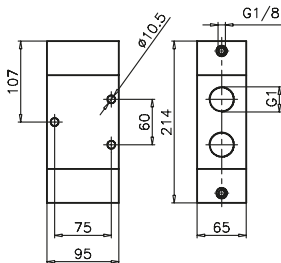

Weight 3330 g
Minimum piloting pressure 2,5 bar

211.32.11.12

5 ways

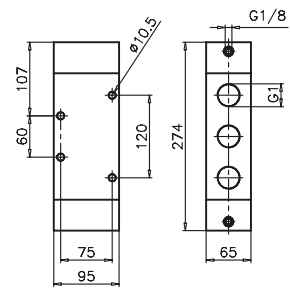

Weight 4200 g
Minimum piloting pressure 2,5 bar

211.52.11.12

Pneumatic - Pneumatic

Coding: 211.1.11.11

Operational characteristics

Fluid	Filtered air. No lubrication needed, if applied it shall be continuous
Max working pressure (bar)	10
Temperature °C	-5 ÷ +70
Flow rate at 6 bar with Δp=1 (NI/min)	6500
Orifice size (mm)	20
Working ports size	G1"
Pilot ports size	G1/8"

TYPE	
32 = 3 ways	
52 = 5 ways	

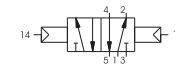
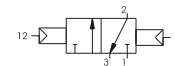

3 ways

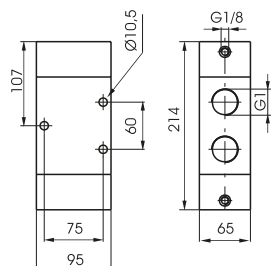

Weight 3330 g
Minimum piloting pressure 2 bar

211.32.11.11

5 ways

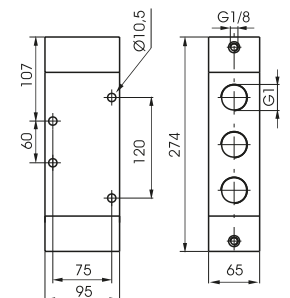

Weight 4200 g
Minimum piloting pressure 2 bar

211.52.11.11

AIR DISTRIBUTION

Pneumatic - Pneumatic 5 ways 3 connections

Coding: 211.53.F.11.11

Operational characteristics	
Fluid	Filtered air. No lubrication needed, if applied it shall be continuous
Max working pressure (bar)	10
Temperature °C	-5 ÷ +70
Flow rate at 6 bar with Δp=1 (l/min)	6500
Orifice size (mm)	20
Working ports size	G1"
Pilot ports size	G1/8"

FUNCTION	
F	31 = Closed centres
	32 = Open centres
	33 = Pressured centres

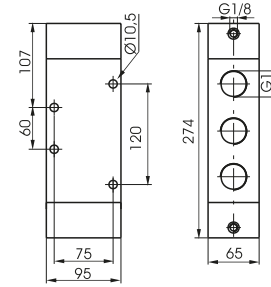
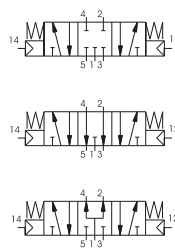

Weight 4200 g
Minimum piloting pressure 3 bar

1
AIR DISTRIBUTION