

GB WARRANTY

Our products are guaranteed for a period of 12 months after the date of delivery. Warranty will not be acknowledged if the products are not used according to the manufacturer's instruction or are badly maintained. Always ask for original Spare-parts, otherwise warranty will not be acknowledged.

F GARANTIE

Nos produits sont garantis pour 12 mois à partir de la date de livraison. Aucune garantie ne sera reconnue, suite au mauvais entretien ou emploi anormal des produits. Pour tous vos besoins de pièces de rechange, demandez toujours les rechanges originaux. Au contraire, aucune garantie ne sera reconnue.

D GARANTIE

Die Firma gewährt eine Garantie von 12 Monaten, gerechnet vom Lieferdatum. Zweckfremder Einsatz und/oder nachlässige Wartung schließen jede Garantie aus. Im Bedarfsfall immer Original-Ersatzteile von der Firma anfordern. Anderenfalls kann keine Garantie gewährt werden.

E GARANTÍA

Nuestros productos están garantizados por 12 meses desde la fecha de la entrega. Ninguna garantía será reconocida por malo entretenimiento o por uso incorrecto de los productos. Pidan siempre repuestos originales. En caso contrario no se reconocerá ninguna garantía.

I GARANZIA























I nostri prodotti sono garantiti per mesi 12 dalla consegna. La Ditta si assume la responsabilità per tutti quei particolari che presentassero difetti di materiale o di lavorazione. Non è riconosciuta la garanzia per cattiva manutenzione, anormale impiego e per quelle parti non costruite dalla Ditta. Le riparazioni dovranno essere effettuate presso la fabbrica o da personale autorizzato. Nello stesso istante in cui i prodotti saranno manomessi da terzi, ogni garanzia sarà ritenuta scaduta. Per ogni verifica i prodotti dovranno essere inviati in Porto Franco. Nel caso di effettiva necessità di sostituzione di particolari sarà addebitato il solo costo della mano d'opera. Per il vostro fabbisogno di ricambi chiedete sempre ricambi originali. In caso diverso non sarà riconosciuta alcuna garanzia.

Numero per ordini telefonici:

(+39) 059.414.411

Numero per ordini con fax:

(+39) 059.253.505

Prescrizioni per Montaggio Prescription for Assembly	
	Avvitare con Loctite 2701 Frenaflettiti FORTE (Verde) Screw with Loctite 2701 thread lock STRONG (green)
	Incollare con biadesivo acrilico VHB 3M 4945 Glue with VHB 3M 4945 acrylic biadhesive
	Sigillare con Arexons MOTORSSIL D Seal with Arexons MOTORSSIL D
	Sigillare con Arexons Mastice Seal with Arexons Filler
	Sigillare con Loxeal 59-10 Seal with Loxeal 59-10
	Spruzzare un velo di Molykote D-321R Spray Spray on a light coat of Molykote D-321R
	Incollare con Loctite 454 Glue with Loctite 454
	Avvitare con Loxeal 24-18 Frenaflettiti DEBOLE (Porpora) Screw down with Loxeal 24-18 WEAK (Purple) thread sealer
	Avvitare con Loxeal 55-14 Frenaflettiti MEDIO (Rosso) Screw down with Loxeal 55-14 MEDIUM (Red) thread sealer
	Avvitare con Loxeal 83-21 Frenaflettiti FORTE (Verde) Screw down with Loxeal 83-21 STRONG (Green) thread sealer
	Montare a caldo con RISCALDATORE Assemble hot with HEATER
	Montare con PRESSA Assemble with PRESS
	Lubrificare con GRASSO MINERALE Lubricate with MINERAL GREASE
	Lubrificare con OLIO MOTORE Lubricate with ENGINE OIL
	Coppia serraggio Tolleranza +0/-10% Nm Tightening torque tolerance +0/-10% Nm
	Lubrificare con GRASSO P40 Lubricate with P40 GREASE
	Lubrificare con GRASSO Molykote 1000 Lubricate with Molykote 1000 GREASE
	Lubrificare con GRASSO Molykote PG54 Lubricate with Molykote PG54 GREASE
	Avvitare con Loctite 5331 (Bianca) Screw down with Loctite 5331 (White)
	Lubrificare con GRASSO Molykote G807 Lubricate with Molykote G807 GREASE
	Avvitare con Loxeal 83-55 / Screw with Loxeal 83-55
	Lubrificare con grasso Molykote Longterm W2 Lubricate with grease Molykote Longterm W2
	Verniciato bucciato RAL 7016 Painted RAL 7016

Characteristics and descriptions are not binding. - Données descriptions et illustrations n'engagement pas le constructeur. - Angaben, Beschreibungen, und Illustrationen sind nicht verbindlich. - Notas y ilustraciones no son empéhativas. - Os dados, descrições e ilustrações são fornecidos a título informativo e não comprometem o fabricante. - Dati, descrizioni ed illustrazioni sono forniti a titolo indicativo e non impegnativo.



ANNOVI REVERBERI
The Power of Experience

ANNOVI REVERBERI S.p.A.

Via M.L. King, 3 - 41122 Modena (Italy)

Tel. (+39) 059.414.411 - Telefax (+39) 059.253.505

E-Mail Italia: agricoltura.it@annovireverberi.it

E-Mail export: agriculture.export@annovireverberi.it

Member of



Cod. 950

Control Units
Groupes de commande
Bedienungsarmaturen

Grupo de mando
Gruppi comando

VDR 50

TECHNICAL DATA / DONNÉES TECHNIQUES / TECHNISCHE ANGABEN
CARACTERÍSTICAS TÉCNICAS / CARACTERÍSTICAS TÉCNICAS / CARATTERISTICHE TECNICHE

CONTROL UNITS GROUPES DE COMMANDE BEDIENUNGSARMATUREN GRUPOS DE MANDO GRUPPI COMANDO	OUTPUT DEBIT LEISTUNG CAUDAL PORTATA		PRESSURE PRESSION DRUCK PRESSIONE		N. VALVES N. ROBINETS N. VENTILLEN N. VÁLVULAS N. RUBINETTI	WEIGHT POIDS GEWICHT PESO PESO
	l/min	gpm (US)	bar	psi		
VDR 50	130	34,3	50	725	2 (+2)	kg 2,2



ATTENTION: This manual must be read before beginning installation of the unit.
ATTENTION: Ce livret doit être lu avant d'installer et d'employer le produit.
ACHTUNG: Das vorliegende Handbuch ist vor der Installation und dem Gebrauch des Produkts aufmerksam zu lesen.
ATENCIÓN: Este manual debe ser leído antes de proceder a la instalación y uso del producto.
ATENÇÃO: Este manual deve ser lido antes de proceder à instalação e ao uso do produto.
ATTENZIONE: Il presente libretto va letto prima di procedere all'installazione ed uso del prodotto.

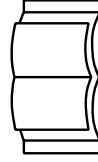

VDR 50 cod. 950 - cod. 904 (con manometro ISOMETRICO)

1048607

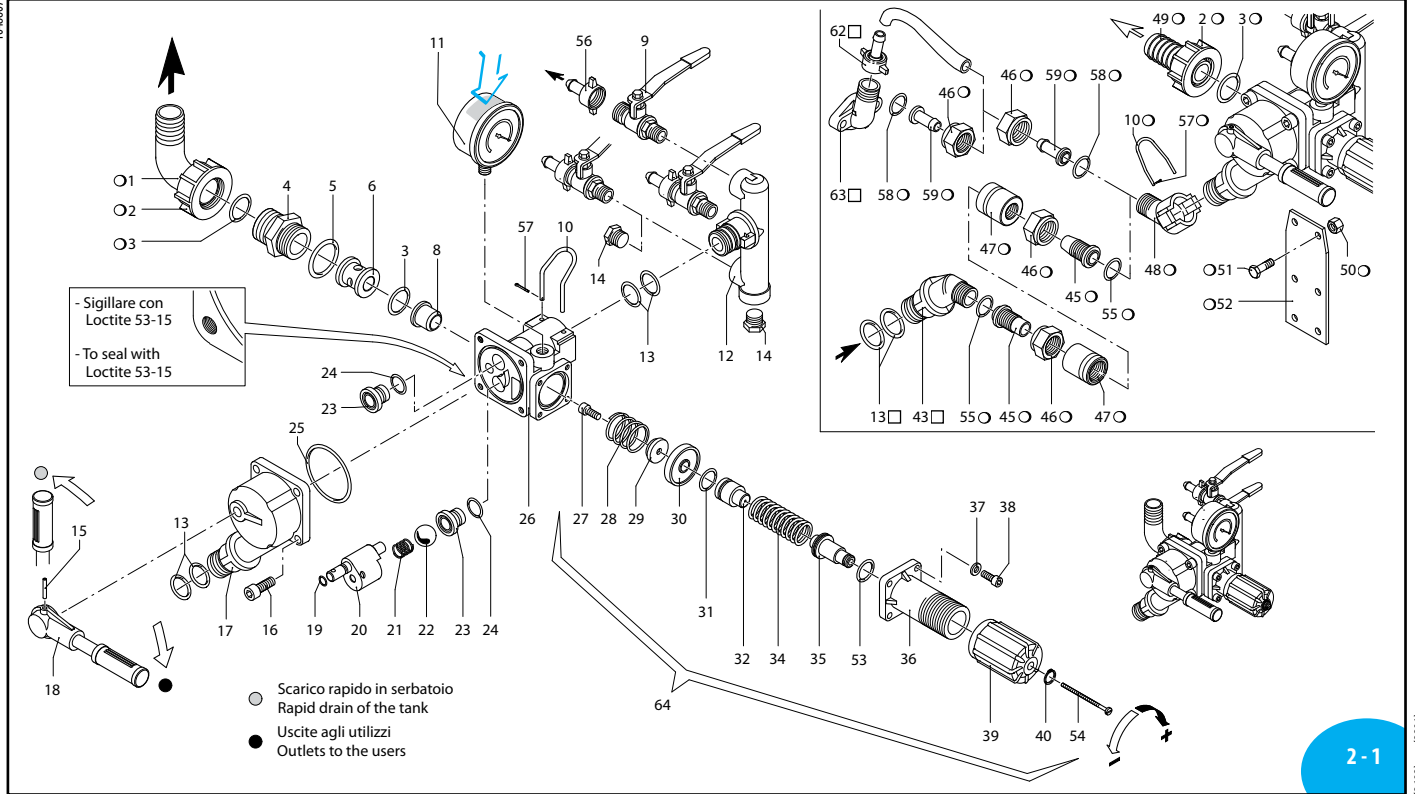

2-1

(3301)

AR000140-JQ

Pos	Cod.	Descrizione	Description	Q.ty	Note
1	550370	Curva Ø 25	Elbow	1	
2	550242	Girello 1" G	Ring nut	1	
3	550350	Guarnizione OR Ø 23,81x2,62	O-ring	2	▶
4	1040780	Raccordo 1" G M-M	Fitting	2	
5	550040	Guarnizione OR Ø 26,65x2,62	O-ring	1	▶
6	1040670	Distanziale	Spacer	1	
8	1040660	Sede	Seat	1	Inox
9	130491	Rubinetto 3/8" G - 1/2" G M-M DX	Cock	3	⊕
10	1040690	Forcella	Fork	2	
11	550545	Manometro Ø 63	Pressure gauge	1	0-80 bar ⊕
	1151010	Manometro Ø63 isometrico	Pressure gauge	1	0-50-80 bar ⊕
12	1040680	Corpo	Body	1	
13	390180	Guarnizione OR Ø 18,72x2,62	O-ring	6	
14	130171	Tappo 3/8" G	Plug	2	⊕ C ₂₀
15	1040820	Spina	Pin	1	
16	108030	Vite TCEI M8x20	Screw	4	⊕ C ₂₀
17	1040720	Corpo distributore	Body	1	
18	1040730	Manopola	Knob	1	
19	1080200	Guarnizione OR Ø 5,6x2,2	O-ring	1	▶
20	1040700	Perno	Hub pin	1	⊗
21	850680	Molla	Spring	1	⊗
22	850660	Sfera	Ball	1	Inox
23	850652	Sede	Seat	2	
24	740290	Guarnizione OR Ø 14x1,78	O-ring	2	▶
25	1040710	Guarnizione OR Ø 56x2	O-ring	1	▶
26	1040600	Corpo	Body	1	
27	680560	Vite TCEI M6x16	Screw	1	Inox ⊕ C ₁₀
28	1040650	Molla	Spring	1	⊗
29	1040640	Valvola	Valve	1	Inox
30	1040630	Membrana	Diaphragm	1	Desmopan ⊗
	1040631	Membrana	Diaphragm	1	NBR ⊗
31	880833	Guarnizione OR Ø 15,54x2,62	O-ring	1	90 Sh ⊗
32	1040622	Pistone	Piston	1	⊗
34	1040830	Molla	Spring	1	⊗
35	394770	Perno	Hub pin	1	
36	1040610	Corpo guida molla	Body	1	
37	550331	Rondella	Washer	4	
38	1040370	Vite TCEI M6x22	Screw	4	C ₄
39	394790	Manopola	Knob	1	
40	480550	Anello seeger øe 12	Ring	1	▶
43	1040760	Raccordo 3/4" G M	Fitting	1	

sp_vdr50.pdf

Pos	Cod.	Descrizione	Description	Q.ty	Note
45	1040810	Portagomma Ø 13x24	Hose tail	2	
	850780	Portagomma Ø 19x34	Hose tail	2	
46	1040790	Girello 3/4" G	Ring nut	2	Per / For ø 13
	850790	Girello 3/4" G	Ring nut	2	Per / For ø 19
47	1040800	Ghiera	Ring nut	2	Per / For ø 13
	850770	Ghiera	Ring nut	2	Per / For ø 19
48	1040770	Raccordo	Fitting	1	
49	550210	Tubo Ø 25	Pipe	1	
50	390270	Dado M8	Nut	2	C ₂₀
51	180370	Vite TE M8x25	Screw	2	C ₂₀
52	850690	Staffa	Bracket	1	
53	770130	Guarnizione OR Ø 20,35x1,78	O-ring	1	⊗
54	1150650	Vite TCTC M3x60	Screw	1	⊕ C ₅
55	960160	Guarnizione OR Ø 17,86x2,62	O-ring	2	▶
56	110131	Girello 1/2"	Ring nut	3	
57	1040950	Copiglia	Split pin	2	
58	880830	Guarnizione OR Ø 15,54x2,62	O-ring	2	▶
59	1150580	Portagomma Ø 13	Hose tail	2	
62	110130	Girello 1/2"	Ring nut	1	
63	450145	Flangia	Flange	1	
64	1362	Kit valvola regolazione	Valve kit adjustment	1	

○ Non compreso nel VDR 50 - No part of VDR 50
 □ Compreso nella pompa - Part of pump

KIT 1955 OR - O-Rings	
Pos.	Q.ty
3	2
5	1
13	2
19	1
24	2
25	1
31	1
53	1
55	2

KIT 1956 (Desmopan) Pronto intervento N° 1 Maintenance repair N° 1			
Pos.	Q.ty	Pos.	Q.ty
3	2	24	2
5	1	25	1
10	1	28	1
13	2	29	1
15	1	30	1
19	1	31	1
21	1	39	1
22	1	53	1
23	2	57	1

KIT 2484 (Desmopan) Pr. interv. N° 2 Mant. rep. N° 2	
Pos.	Q.ty
3	2
5	1
8	1
27	1
29	1
30	1
31	1

VDR 50

		kit I			kit S		
		AR903-AR1053 AR1023	AR713-AR813 AR1064		+ 1 Via	Ø13x24	Ø19x34
VDR 50	950	946	978	946	998	986	987
VDR 50 ISO	904						

Kit per/for VDR 50

<p>KIT 978 "I"</p> <p>UN000505-GF</p>	<p>KIT 991 "S"</p> <p>UN000501-GF</p>	<p>KIT 946 "I" - "S"</p> <p>UN000502-GF</p>
<p>KIT 998 "S"</p> <p>UN000503-GF</p>	<p>KIT 986 "S"</p> <p>UN000504-GF</p>	<p>KIT 987 "S"</p> <p>UN000506-GF</p>

Comando incorporato e separato - Build-in control unit and remote control

KIT 978 "I" Comando incorporato Build in control			
Pos.	Q.ty	Pos.	Q.ty
1	1		
2	1		
3	1		
56	2		
Per / for AR 713 - AR 813 - AR 1064			



KIT 991 "S" Comando separato Remote control			
Pos.	Q.ty	Pos.	Q.ty
2	1	56	3
3	1	57	1
9	1	58	1
10	1	59	1
46	1		
48	1		
49	1		
50	2		
51	2		
52	1		
Per / for AR 30 - AR 40 - AR 50			

KIT 946 "S" Comando separato Remote control		KIT 946 "I" Comando incorporato Build in control	
Pos.	Q.ty	Pos.	Q.ty
2	1	2	1
3	1	3	1
10	1	10	1
48	1	48	1
49	1	49	1
57	1	57	1
Per / for AR 503 - AR 713 AR 813 - AR 1064 AR 903 - AR 1053 AR 1203 BHA/BHS/BHP 130		Per / for AR 903 AR 1053 - AR 1203 BHS 90 - 105 - 120	

KIT 998 "S" Comando separato Remote control			
Pos.	Q.ty	Pos.	Q.ty
2	1	52	1
3	1	56	3
9	1	57	1
10	1	58	2
46	2	59	2
48	1		
49	1		
50	2		
51	2		
Per / for AR 503 - AR 903 - AR 1053 - AR 1203 AR 713 - AR 813 - AR 1064 - AR 1265 BHA/BHS/BHP 130			

KIT 986 "S" Comando separato Remote control			
Pos.	Q.ty	Pos.	Q.ty
2	1	51	2
3	1	52	1
9	1	55	2
10	1	56	3
45	2	57	1
46	2		
47	2		
48	1		
49	1		
50	2		
Per / for AR 503 - AR 713 - AR 813			

KIT 987 "S" Comando separato Remote control			
Pos.	Q.ty	Pos.	Q.ty
2	1	51	2
3	1	52	1
10	1	55	2
45	2	56	2
46	2	57	1
47	2		
48	1		
49	1		
50	2		
Per / for AR 903 - AR 1053 - AR 1203 AR 1064 - BHA/BHS/BHP 130			

GB

DESCRIPTION AND USE

The VDR 50 control unit is designed for regulating working pressure in the distribution of sprayed liquids.

Numbers in the text refer to the exploded view of the product. VDR 50 comprises a pressure regulating diaphragm valve with a manual adjustment knob (39). The main body is also equipped with a rapid drain valve. The pressurised outlet to the users is connected through a 4-way manifold with 2 outlet valves (+2 optional valves).

INSTALLATION ON PUMP

1. Lubricate and install the O-rings (13) on the body (17) and attach the body to the pump outlet line; secure with fork (10).
2. Connect the drain port (1) to the tank directly without intermediate flow restriction elements.
3. Connect the high pressure hoses to the outlet valves.

REMOTE INSTALLATION

1. Firmly secure the mounting bracket (52).
2. Lubricate and install the O-rings (13) on the body (17) and fit the latter to the coupling (48); secure with fork (10).
3. Connect the quick connecting to the high pressure hose from the pump and then connect VDR 50 to the pump outlet.
4. Connect the drain port (1) to the tank directly without intermediate flow restriction elements.
5. Connect the high pressure hoses to the outlet valves.

USE

1. Refer to the pump user handbook.
2. Check for possible leaks in the hydraulic circuit from connections and unions by circulating water through the system.
3. The two position lever (18) controls rapid drain of the tank when positioned vertically (°) and feeds the outlets to the users when positioned horizontally (•).
4. Use knob (39) to regulate working pressure: turn clockwise to increase pressure (+) counter-clockwise to decrease (-).
5. Flush the control unit with water when you finish work to remove any internal deposits of aggressive products.

SAFETY INSTRUCTIONS

This manual must be stored carefully. Read and follow the following safety instructions:

- Do not use the unit with flammable liquids, or liquids with characteristics not compatible with the correct functioning of the unit.
- The installation of the unit must be carried out by qualified staff.



F

DESCRIPTION ET MODE D'UTILISATION

L'unité de commande VDR 50 régle la pression d'utilisation dans la distribution du liquide d'érosage.

Les chiffres rappelés dans le texte correspondent aux repères sur l'éclaté.

VDR 50 est constituée d'un régulateur de pression à membrane à tarage manuel par la poignée (39). Dans le corps principal du régulateur est incorporé un clapet de décharge rapide.

La sortie sous pression vers les utilisations est canalisée par 2 robinets (+ 2 en option).

MONTAGE SUR LA POMPE

1. Lubrifier et monter les joints toriques (13) sur le corps de la pompe (17) en plaçant ce dernier dans le conduit de roulement de la pompe, puis fixer au moyen de la fourchette (10).
2. Raccorder la décharge (1) directement à la citerne, sans étranglements.
3. Raccorder les tuyaux HP aux robinets en sortie.

MONTAGE A DISTANCE

1. Monter solidement la bride (52).
2. Lubrifier et monter les joints toriques (13) sur le corps de la pompe (17) en plaçant ce dernier dans la fixation (48), puis fixer au moyen de la fourchette (10).
3. Assembler les raccords rapides au tube HP de raccordement avec la pompe, puis brancher VDR 50 au roulement de la pompe.
4. Raccorder la décharge (1) directement à la citerne, sans étranglements.
5. Raccorder les tuyaux HP aux robinets en sortie.

MODE D'UTILISATION

1. Suivre les instructions de fonctionnement de la pompe.
2. Contrôler les fuites éventuelles du circuit hydraulique à la hauteur des jonctions et des raccords, en faisant circuler de l'eau.
3. Le levier à 2 positions (18) commande la décharge rapide au réservoir en position verticale (°). Vice versa, en position horizontale (•), il alimente les sorties vers les utilisations.
4. La poignée (39) régle la pression d'utilisation: une rotation dans le sens des aiguilles d'une montre augmente la pression (+), une rotation dans le sens contraire diminue la pression (-).
5. Laver l'unité de commande entièrement à l'eau après le travail. Veiller à éliminer toute stagnation des produits agressifs.



INSTRUCTIONS DE SÉCURITÉ

Conservier ce manuel avec le plus grand soin. Lire et respecter les instructions de sécurité ci-dessous:

- Ne pas utiliser le produit avec des fluides inflammables ou ayant des caractéristiques incompatibles avec le fonctionnement correct du produit lui-même.
- L'installation du produit doit être effectuée par un personnel qualifié.

D

BESCHREIBUNG UND GEBRAUCH

Das Steueraggregat VDR 50 dient zur Einstellung des Betriebsdrucks bei der Verteilung des Sprühmittels.

Die in Klammern angegebenen Zahlen beziehen sich auf die Explosionszeichnung des Produkts. VDR 50 besteht aus einem Membran-Druckregelventil, das sich durch den Handgriff (39) manuell einstellen läßt. Im gleichen Hauptkörper ist das Schnellabläßventil eingebaut. Die Druckweiterführung zu den Verbrauchern erfolgt über eine 4-Wege-Sammelleitung mit 2 Ventilen (+2 auf Wunsch).

PUMPENMONTAGE

1. Die O-Ringe (13) schmieren und an den Körper (17) anbringen, danach den Körper drucksseitig an die Pumpe anschließen und mit Gabel (10) befestigen.
2. Die Abfuhrleitung (1) direkt, ohne Drosselstellen, an den Tank anschließen.
3. Die Hochdruckleitungen an die Ausblöventile anschließen.

FERNMONTAGE

1. Den Bügel (52) fest anbringen.
2. Die O-Ringe (13) schmieren und an den Körper (17) anbringen, danach den Körper in den Anschluß (48) stecken und mit Gabel (10) befestigen.
3. Die Schnellanschlüsse an die Hochdruckleitung zum Pumpenanschluß anbringen, danach VDR 50 drucksseitig an die Pumpe anschließen.
4. Die Abfuhrleitung (1) direkt, ohne Drosselstellen, an den Tank anschließen.
5. Die Hochdruckleitungen an die Ausblöventile anschließen.

GEBRAUCH

1. Siehe Betriebsanleitung der Pumpe.
2. Durch Wasserkirkulation überprüfen, ob im Hydraulikkreis an den Anschlüssen bzw. Verbindungen Leckstellen bemerkbar sind.
3. Der Hebel (18) steuert in vertikaler Stellung (°) den Schnellablaß in den Tank. In horizontaler Stellung (•) hingegen werden die Verbraucher versorgt.
4. Durch den Handgriff (39) läßt sich der Betriebsdruck einstellen. Beim Drehen im Uhrzeigersinn wird der Druck erhöht (+), beim Drehen gegen den Uhrzeigersinn verringert (-).
5. Nach dem Betrieb ist das Steueraggregat mit Wasser auszuspülen, um Rückstände aggressiver Produkte zu entfernen.



SICHERHEITSAHLUTUNGEN

Vorligendes Handbuch sorgfältig aufbewahren und folgende Sicherheitsanleitungen aufmerksam lesen und beachten:

- Produkt nicht mit entzündbaren oder sonstigen Flüssigkeiten verwenden, deren Eigenschaften mit einem einwandfreien Betrieb des Produkts nicht vereinbar sind.
- Die Produktinstallation ist von qualifiziertem Fachpersonal vorzunehmen.

E

DESCRIPCIÓN Y MODO DE USO

El grupo de mando VDR 50 sirve para regular la presión de trabajo en la distribución de líquido para pulverización.

Las indicaciones numéricas se refieren al gráfico de despiece del producto.

VDR 50 está compuesto por una válvula de regulación de la presión a membrana, que se calibra manualmente con la perilla (39). La salida a presión está canalizada por un colector de 4 vías, con dos grifos (+ 2 opcionales).

MONTAJE SOBRE LA BOMBA

1. Lubricar y montar las juntas tóricas (13) sobre el cuerpo (17), introduciendo este último en el conductor de impulsión de la bomba y fijar con la horquilla (10).
2. Conectar directamente la descarga (1) a la sistema, sin producir obstrucciones.
3. Conectar los tubos de alta presión a los grifos en salida.

MONTAJE A DISTANCIA

1. Montar el soporte firmemente (52).
2. Lubricar y montar las juntas tóricas (13) sobre el cuerpo (17), introduciendo este último en la conexión (48) y fijar con la horquilla (10).
3. Ensamblar los racores rápidos al tubo de alta presión de conexión con la bomba y, luego, conectar VDR 50 al conductor de impulsión de la bomba.
4. Conectar directamente la descarga (1) a la sistema, sin producir obstrucciones.
5. Conectar los tubos de alta presión a los grifos en salida.

MODO DE USO

1. Reñitirse a las instrucciones operativas de la bomba.
2. Controlar, haciendo circular el agua, que no haya pérdidas ni en las juntas y ni en los racores del circuito hidráulico.
3. La palanca de dos posiciones (18), en posición vertical (°), manda la descarga rápida en el depósito. Viceversa, en posición horizontal (•), alimenta las salidas.
4. Mediante la perilla (39) se regula la presión de trabajo: girarla (+) y en sentido contrario al de las manecillas del reloj, disminuye (-).
5. Después del trabajo, lavar internamente con agua el grupo de mando y quitar eventuales restos de productos agresivos.



INSTRUCCIONES PARA LA SEGURIDAD

Es necesario conservar con cuidado el presente manual, leer y respetar las siguientes instrucciones para la seguridad:

- No utilizar el producto con fluidos inflamables o que tengan características no compatibles con el correcto funcionamiento del producto.
- La instalación del producto debe ser efectuada por personal especializado.

I

DESCRIZIONE E MODO D'USO

Il gruppo comando VDR 50 serve per la regolazione della pressione di lavoro nella distribuzione del liquido per l'irrorazione.

I richiami numerici fanno riferimento al disegno esploso del prodotto.

È composto da una valvola di regolazione della pressione a membrana, tarabile manualmente attraverso la manopola rossa (39). Nello stesso corpo praticabile vi è inserita la valvola di scarico rapida. L'uscita in pressione agli utilizzi è canalizzata da un collettore a 4 vie, con 2 rubinetti (+ 2 opzionali).

MONTAGGIO SULLA POMPA

1. Lubrificare e montare gli OR (13) sul corpo (17), inserendo quest'ultimo nel condotto di mandata della pompa, fissare con la forcilla (10).
2. Collegare lo scarico (1) alla sistema, senza strozzature, direttamente.
3. Collegare i tubi alta pressione ai rubinetti in uscita.

MONTAGGIO A DISTANZA

1. Montare saldamente la staffa (52).
2. Lubrificare e montare gli OR (13) sul corpo (17), inserendo quest'ultimo nell'attacco (48), fissare con la forcilla (10).
3. Assemblare i raccordi rapidi al tubo alta pressione di collegamento con la pompa, quindi collegare VDR 50 alla mandata della pompa.
4. Collegare lo scarico (1) alla sistema, senza strozzature, direttamente.
5. Collegare i tubi alta pressione ai rubinetti in uscita.

MODALITÀ D'USO

1. Fare riferimento alle istruzioni operative della pompa.
2. Controllare facendo circolare acqua, eventuali perdite del circuito idraulico nelle giunzioni e nei raccordi.
3. La leva a due posizioni (18) comanda lo scarico rapido in serbatoio in posizione verticale (°). Viceversa in posizione orizzontale (•) alimenta le uscite agli utilizzi.
4. Mediante la manopola (39) si regola la pressione di lavoro: in senso orario aumenta la pressione (+), in senso antiorario diminuisce (-).
5. Lavare il gruppo comando internamente con acqua dopo il lavoro, togliendo eventuali ristagni di prodotti aggressivi.



ISTRUZIONI PER LA SICUREZZA

È necessario conservare con cura il presente manuale, leggere e rispettare le seguenti istruzioni per la sicurezza:

- Non utilizzare il prodotto con fluidi infiammabili o aventi caratteristiche non compatibili con il corretto funzionamento del prodotto stesso.
- L'installazione del prodotto deve essere effettuata da personale qualificato.