

ITEM	QTY	DIMENSIONS	MATERIAL
1	1	TANK BODY	ALUMINUM 2,5 MM
2	2	SIDE PLATE	ALUMINUM 2 MM
3	2	BRACKET	DC01 QUALITY ST-37 5mm
4	2	BELT	6112 QUALITY 2mm.STEEL
5	2	BELT RUBBER	RUBBER
6	1	LONG OIL INDICATOR	
7	1	FILLING NECK	PLASTIC
8	4	BRACKET RUBBER	RUBBER
9	1	FILTER SYSTEM	
10	1	SUCTION ADAPTER	ALM. 2" FEMALE
11	2	PIN ASSEMBLY KIT	11 SMN PB30 QUALITY AUTOMAT Ø20 STEEL
12	4	RIVET	M8 (4x)

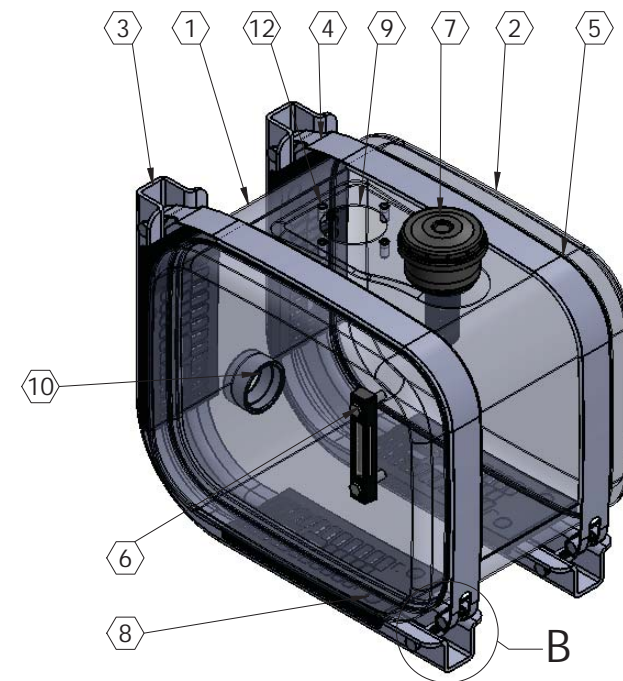

HYDNEX

MSHN065

Alumiinisäiliö 65L