

ISO 16028

VALVOLA PIANA/ACCIAIO INOX
 FLAT FACE/STAINLESS STEEL
 FLACHDICHTEND/EDELSTAHL
 CLAPET PLAT/ACIER INOX

Caratteristiche tecniche

- Norma: ISO 16028
- Occlusione: faccia piana
- Aggancio: sfere radiali
- Materiale: acciaio inox AISI 316
- Filettature: BSP - NPT - SAE
- Guarnizioni standard: FKM
- Temperatura d'esercizio: -25 °C +200 °C
- Guarnizioni opzionali: EPDM, FFKM o altro
- Pressioni di esercizio: 100-400 bar
- Connessione in pressione: non consentita

Nominal size				Max working pressure	Rated flow	Max flow rate	Min burst pressure			Fluid spillage
DNP	BG	ISO	mm				Male	Female	Coupled	
06	1	6.3	6	40	12	24	260	160	130	0,008
13	2	10	8,6	25	23	46	140	100	190	0,010
20	3	12.5	10,7	25	45	90	130	100	160	0,012
22	4A	16	12,8	25	74	150	110	100	140	0,015
25	4	19	14,8	25	100	200	110	100	140	0,020
30	5	25	17,6	25	189	280	100	100	100	0,030
39	7	40	30	15	379	700	60	60	60	0,050
50	8	50	40,6	10	757	1000	40	40	40	0,100

1 MPa = 145,04 psi • 1 l = 0,264 gal

Technical data

- Standard: ISO 16028
- Occlusion: flat face
- Locking: radial balls
- Material: stainless steel AISI 316
- Threads: BSP - NPT - SAE
- Standard seals: FKM
- Working temperature: -25 °C +200 °C
- Optional seals: EPDM, FFKM or more
- Working pressure: 100-400 bar
- Connection under pressure: not allowed

Technische Merkmale

- Norm: ISO 16028
- Verschluss: flachdichtend
- Kupplung: Radialkugeln
- Werkstoff: rostfreiem Stahl AISI 316
- Gewinde: BSP - NPT - SAE
- Standard-Dichtungen: FKM
- Betriebstemperatur: -25 °C +200 °C
- Dichtungen nach Wahl: EPDM, FFKM, usw.
- Betriebsdruck: 100-400 bar
- Kuppeln unter Druck: nicht möglich

Caracteristiques techniques

- Norme: ISO 16028
- Obturation: clapet plat
- Accrochage: billes radiales
- Matériel: acier inoxydable AISI 316
- Taraudage: BSP - NPT - SAE
- Joints standard: FKM
- Température de service: -25 °C +200 °C
- Joints facultatifs: EPDM, FFKM, ect.
- Pression de service: 100-400 bar
- Connexion sous pression: pas possible

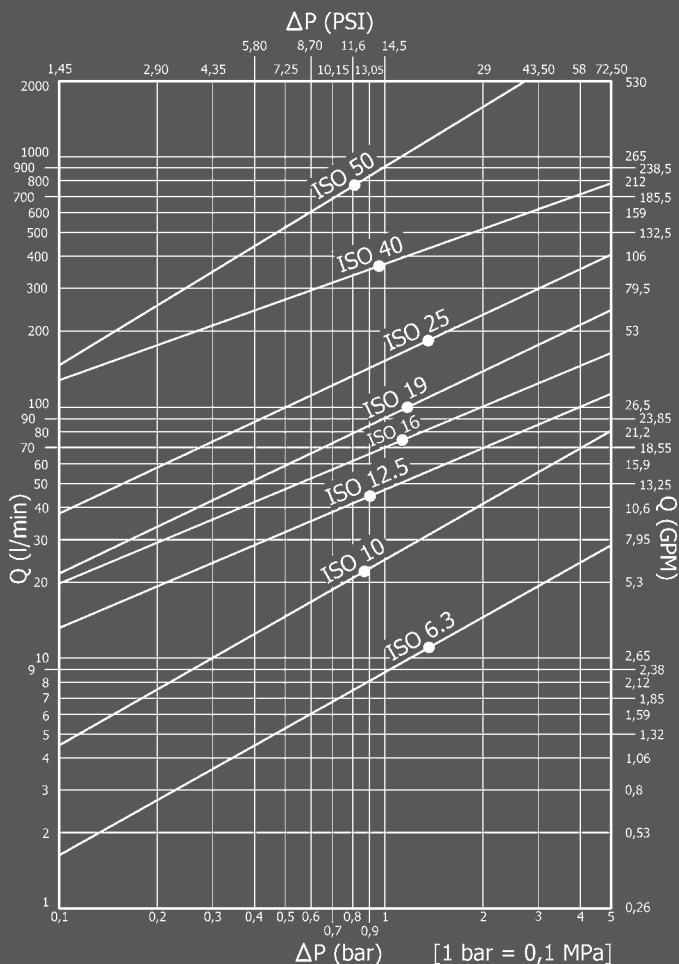

PLTX DN06 - BG 1 - ISO 6.3

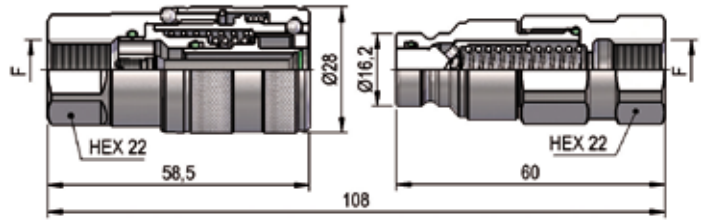

THREADS	F	STANDARD	FEMMINA - FEMALE - MUFFE - FEMELLE			MASCHIO - MALE - STECKER - MALE		
			COD. F	Weight (g)	Packaging (pcs.)	COD. M	Weight (g)	Packaging (pcs.)
IG 1	BSP 1/4"	DIN 3852-2-X	PLTX.0606.112	186	100	PLTX.0606.113	121	200
	NPT 1/4"	ANSI B1.20.3	PLTX.0606.012	187	100	PLTX.0606.013	122	200
IG 2	9/16"-18 UNF 2B	SAE J 1926-1	PLTX.0615.032	183	100	PLTX.0615.033	118	200

PLTX DN13 - BG 2 - ISO 10

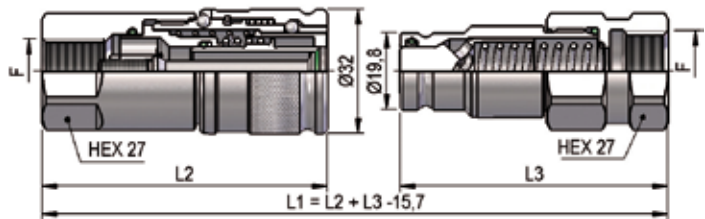

THREADS	L2	L3	F	STANDARD	FEMMINA - FEMALE - MUFFE - FEMELLE			MASCHIO - MALE - STECKER - MALE		
					COD. F	Weight (g)	Packaging (pcs.)	COD. M	Weight (g)	Packaging (pcs.)
IG 1	73,5	69,5	BSP 3/8"	DIN 3852-2-X	PLTX.1310.112	298	60	PLTX.1310.113	172	76
	73,5	69,5	NPT 3/8"	ANSI B1.20.3	PLTX.1310.012	300	60	PLTX.1310.013	175	76
	73,5	69	BSP 1/2"	DIN 3852-2-X	PLTX.1313.112	286	60	PLTX.1313.113	156	76
	73,5	73	NPT 1/2"	ANSI B1.20.3	PLTX.1313.012	287	60	PLTX.1313.013	171	76
IG 2	73,5	70	3/4"-16 UNF 2B	SAE J 1926-1	PLTX.1319.032	290	60	PLTX.1319.033	174	76

PLTX DN20 - BG 3 - ISO 12.5

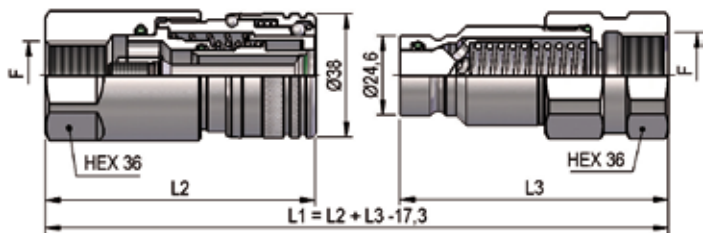

THREADS	L2	L3	F	STANDARD	FEMMINA - FEMALE - MUFFE - FEMELLE			MASCHIO - MALE - STECKER - MALE		
					COD. F	Weight (g)	Packaging (pcs.)	COD. M	Weight (g)	Packaging (pcs.)
IG 1	83,5	81,5	BSP 1/2"	DIN 3852-2-X	PLTX.2013.112	544	35	PLTX.2013.113	351	42
	83,5	82	NPT 1/2"	ANSI B1.20.3	PLTX.2013.012	549	35	PLTX.2013.013	358	42
	83,5	83	BSP 3/4"	DIN 3852-2-X	PLTX.2019.112	510	35	PLTX.2019.113	326	42
	83,5	83	NPT 3/4"	ANSI B1.20.3	PLTX.2019.012	519	35	PLTX.2019.013	336	42
IG 2	83,5	83	1 1/16"-12 UN 2B	SAE J 1926-1	PLTX.2027.032	508	35	PLTX.2027.033	324	42

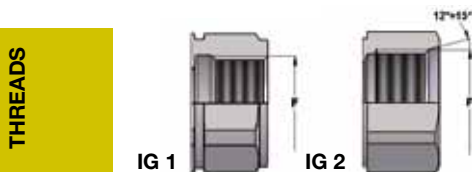

PLTX DN22 - BG 4A - ISO 16

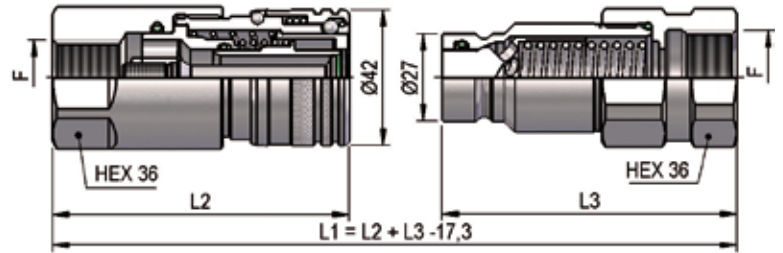

THREADS	L2	L3	F	STANDARD	FEMMINA - FEMALE - MUFFE - FEMELLE			MASCHIO - MALE - STECKER - MALE		
					COD. F	Weight (g)	Packaging (pcs.)	COD. M	Weight (g)	Packaging (pcs.)
IG 1	86	81,5	BSP 1/2"	DIN 3852-2-X	PLTX.2213.112	591	30	PLTX.2213.113	376	42
	86	82	NPT 1/2"	ANSI B1.20.3	PLTX.2213.012	596	30	PLTX.2213.013	383	42
	86	83	BSP 3/4"	DIN 3852-2-X	PLTX.2219.112	557	30	PLTX.2219.113	351	42
	86	83	NPT 3/4"	ANSI B1.20.3	PLTX.2219.012	566	30	PLTX.2219.013	361	42
IG 2	86	83	1"1/16-12 UN 2B	SAE J 1926-1	PLTX.2227.032	555	30	PLTX.2227.033	349	42

PLTX DN25 - BG 4 - ISO 19

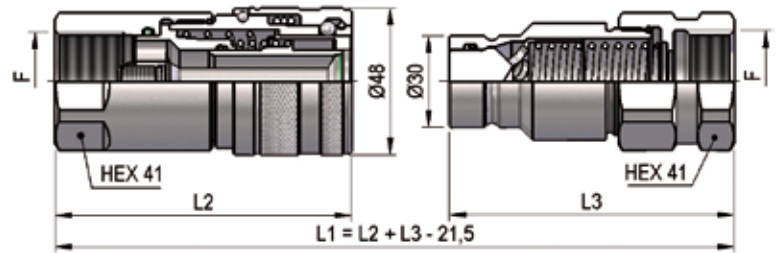

THREADS	L2	L3	F	STANDARD	FEMMINA - FEMALE - MUFFE - FEMELLE			MASCHIO - MALE - STECKER - MALE		
					COD. F	Weight (g)	Packaging (pcs.)	COD. M	Weight (g)	Packaging (pcs.)
IG 1	95,5	90,5	BSP 3/4"	DIN 3852-2-X	PLTX.2519.112	850	23	PLTX.2519.113	496	30
	95,5	90,5	NPT 3/4"	ANSI B1.20.3	PLTX.2519.012	855	23	PLTX.2519.013	503	30
	97,5	90,5	BSP 1"	DIN 3852-2-X	PLTX.2525.112	803	23	PLTX.2525.113	451	30
	97,5	93,5	NPT 1"	ANSI B1.20.3	PLTX.2525.012	814	23	PLTX.2525.013	480	30
IG 2	95	93,5	1"5/16-12 UN 2B	SAE J 1926-1	PLTX.2533.032	794	23	PLTX.2533.033	431	30

THREADS

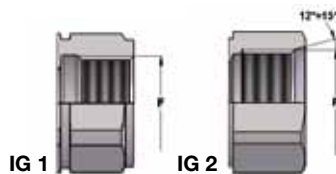

PLTX DN30 - BG 5 - ISO 25

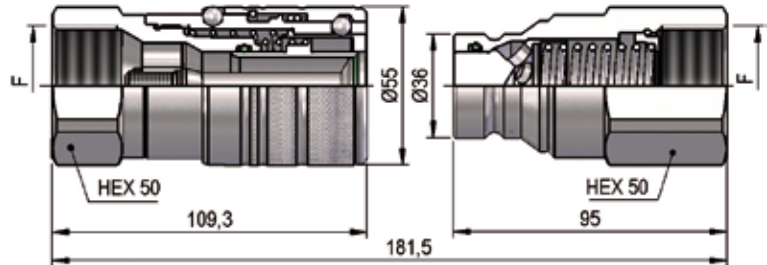

F	STANDARD	FEMMINA - FEMALE - MUFFE - FEMELLE			MASCHIO - MALE - STECKER - MALE		
		COD. F	Weight (g)	Packaging (pcs.)	COD. M	Weight (g)	Packaging (pcs.)
BSP 1"¼	DIN 3852-2-X	PLTX.3031.112	1164	7	PLTX.3031.113	744	20
NPT 1"¼	ANSI B1.20.3	PLTX.3031.012	1188	7	PLTX.3031.013	757	20

PLTX DN39 - BG 7 - ISO 40

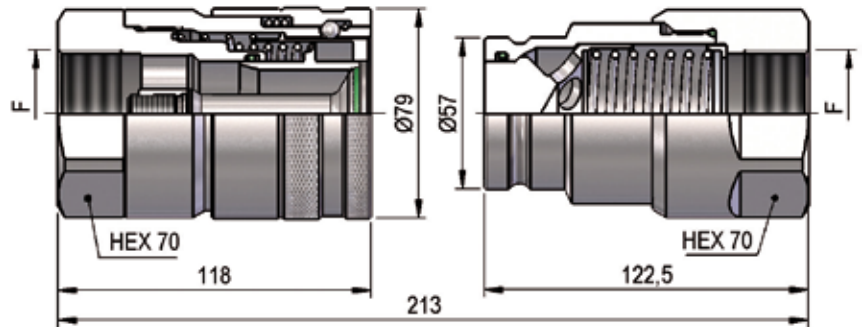

F	STANDARD	FEMMINA - FEMALE - MUFFE - FEMELLE			MASCHIO - MALE - STECKER - MALE		
		COD. F	Weight (g)	Packaging (pcs.)	COD. M	Weight (g)	Packaging (pcs.)
BSP 1"½	DIN 3852-2-X	PLTX.3939.112	2844	5	PLTX.3939.113	2134	8
NPT 1"½	ANSI B1.20.3	PLTX.3939.012	2859	5	PLTX.3939.013	2149	8

PLTX DN50 - BG 8 - ISO 50

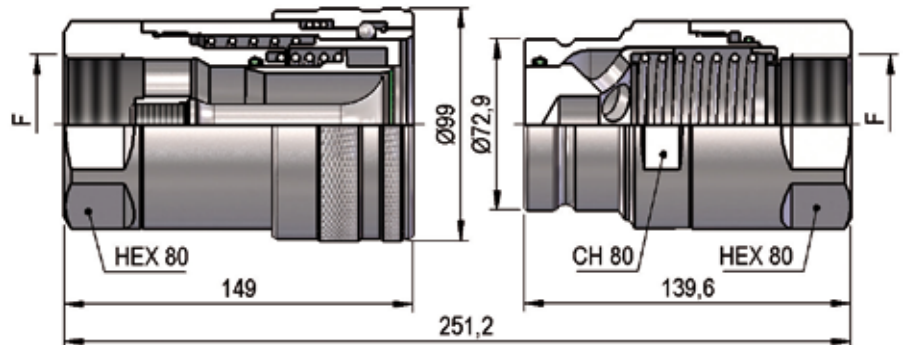

F	STANDARD	FEMMINA - FEMALE - MUFFE - FEMELLE			MASCHIO - MALE - STECKER - MALE		
		COD. F	Weight (g)	Packaging (pcs.)	COD. M	Weight (g)	Packaging (pcs.)
BSP 2"	DIN 3852-2-X	PLTX.5051.112	4790	5	PLTX.5051.113	3200	6
NPT 2"	ANSI B1.20.3	PLTX.5051.012	4650	5	PLTX.5051.013	3110	6

PLASTIC CAPS

NOMINAL SIZE				FEMALE DUST PLUG				MALE DUST CAP				COLOUR	MATERIAL	
DNP	BG	ISO	COD. F	Dimensions			Weight	COD. M	Dimensions					Weight
				D	L	D1	(g)		D	L	D1	(g)		
06	1	6.3	SPLT.06002	32,5	200	20	16	SPLT.06003	26	200	20	13	●	PVC
13	2	10	SPLT.13002	37	200	26	21	SPLT.13003	27,5	200	26	15	●	PVC
20	3	12.5	SPLT.20002	43	200	31,5	29	SPLT.20003	35	200	31,5	26	●	PVC
25	4	19	SPLT.25002	53,5	265	35	51	SPLT.25003	43	265	35	41	●	PVC
30	5	25	SPLT.30002	63	280	48	92	SPLT.30003	50	280	48	66	●	PVC

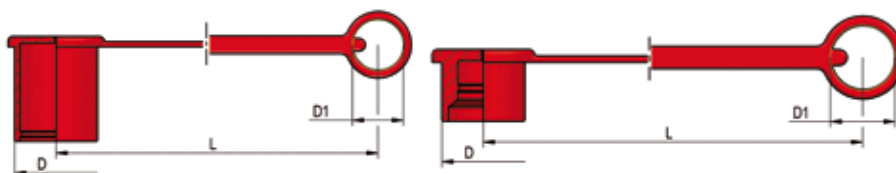

METAL CAPS

NOMINAL SIZE				FEMALE DUST PLUG				MALE DUST CAP				MATERIAL	
DNP	BG	ISO	COD. F	Dimensions			Weight	COD. M	Dimensions				Weight
				D	L	D1	(g)		D	L	D1	(g)	
06	1	6.3	SPLT.06202	46	200	32	41	SPLT.06203	33	200	32	28	Aluminum
13	2	10	SPLT.13202	40	200	32	48	SPLT.13203	30	200	32	39	Aluminum
20	3	12.5	SPLT.20202	60	200	32	53	SPLT.20203	42	200	32	40	Aluminum
22	4A	16	SPLT.22202	66	200	32	63	SPLT.22203	46	200	32	43	Aluminum
25	4	19	SPLT.25202	55	275	47,5	74	SPLT.25203	40	275	47,5	66	Aluminum
30	5	25	SPLT.30202	65	275	47,5	126	SPLT.30203	45	275	47,5	71	Aluminum
39	7	40	SPLT.39202	90	275	47,5	207	SPLT.39203	68	275	47,5	155	Aluminum
50	8	50	SPLTX.50202	110	275	47,5	320	SPLK.50203	83	275	47,5	210	Aluminum

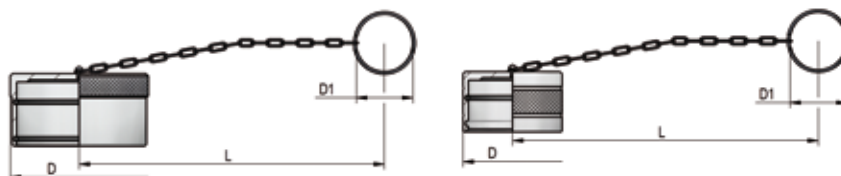

AUTOMATIC CAPS

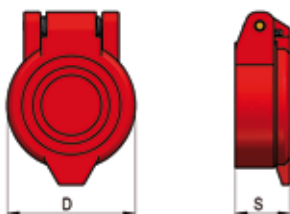

NOMINAL SIZE				AUTOMATIC FEMALE CAP			COLOUR	MATERIAL
DNP	BG	ISO	COD. F	Dimensions		Weight		
				D	S	(g)		
13	2	10	SPLT.13302	38	16,8	17	●	Nylon
13	2	10	SPLT.13342	38	16,8	17	●	Nylon
20	3	12.5	SPPV.13302	46	18,4	24	●	Nylon
20	3	12.5	SPPV.13312	46	18,4	24	●	Nylon
20	3	12.5	SPPV.13322	46	18,4	24	●	Nylon
20	3	12.5	SPPV.13332	46	18,4	24	●	Nylon
20	3	12.5	SPPV.13342	46	18,4	24	●	Nylon

SPARE PARTS



NOMINAL SIZE			MALE GASKET	
DNP	BG	ISO	OR (VITON)	BK (PTFE)
06	1	6.3	PLT.006.120 V	PLT.006.130
13	2	10	PLT.013.120 V	PLT.013.130
20	3	12.5	PLT.019.120 V	PLT.019.130
22	4A	16	PLT.022.120 V	PLT.022.130
25	4	19	PLT.025.120 V	PLT.025.130
30	5	25	PLT.031.120 V	PLT.031.130
39	7	40	PLT.039.120 V	PLT.039.130
50	8	50	PLTX.050.120 V	PLTX.050.130